

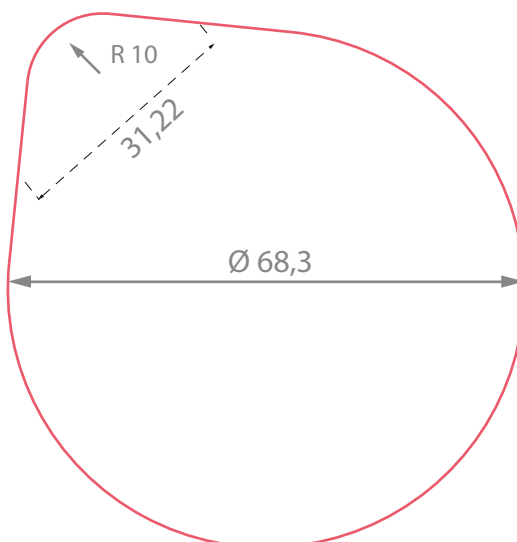

ALU·LIDS

Nowoczesna technologia = niewielki koszt  
Prosimy o przesłanie rysunku technicznego lub stoiczka, dobierzemy dla Państwa odpowiedni kształt i rozmiar lub wykonamy zupełnie nowy wzór

**10**  
**mm**

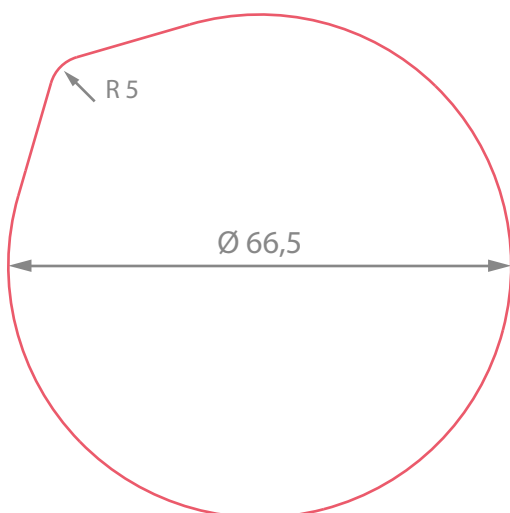
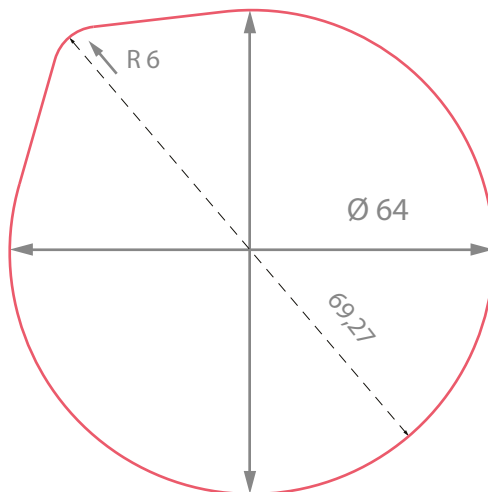
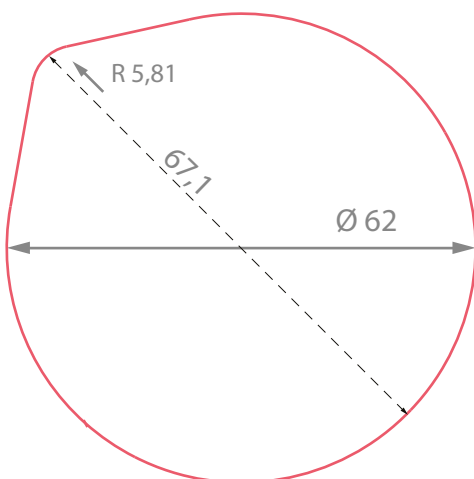
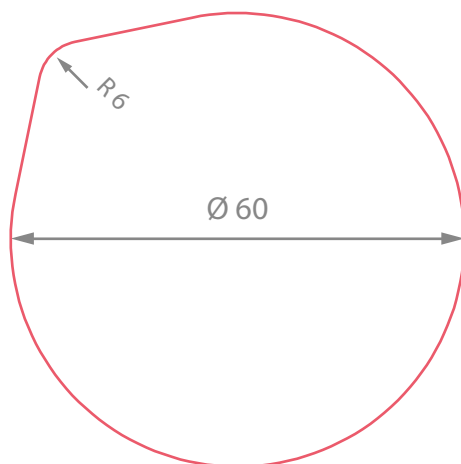
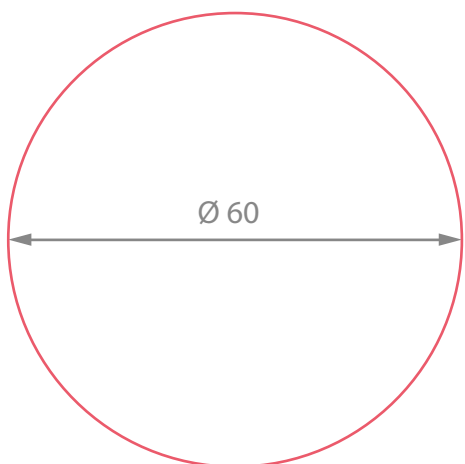



ALU·LIDS

Nowoczesna technologia = niewielki koszt  
Prosimy o przesłanie rysunku technicznego lub słoiczka, dobierzemy dla Państwa odpowiedni kształt i rozmiar lub wykonamy zupełnie nowy wzór

**10**  
**mm**

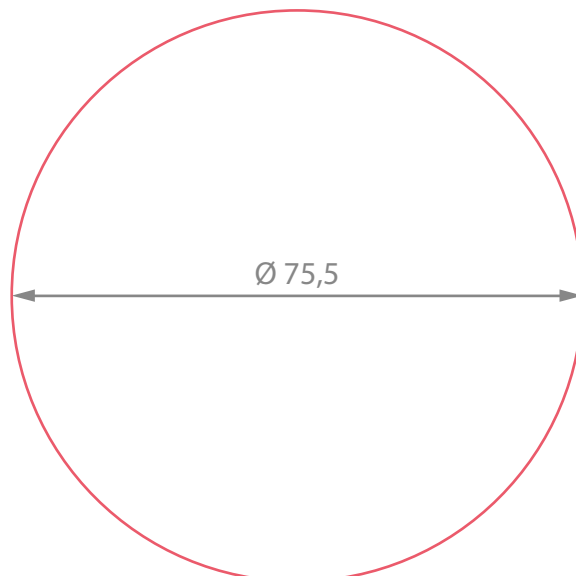
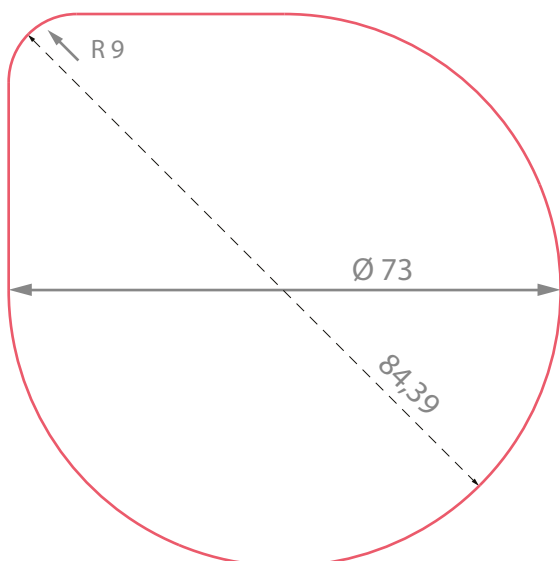
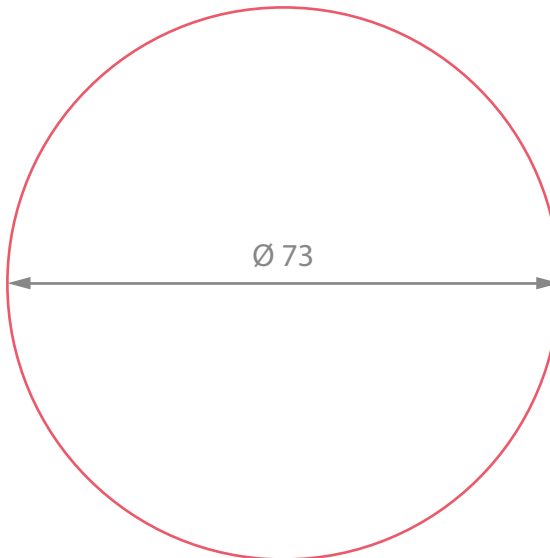
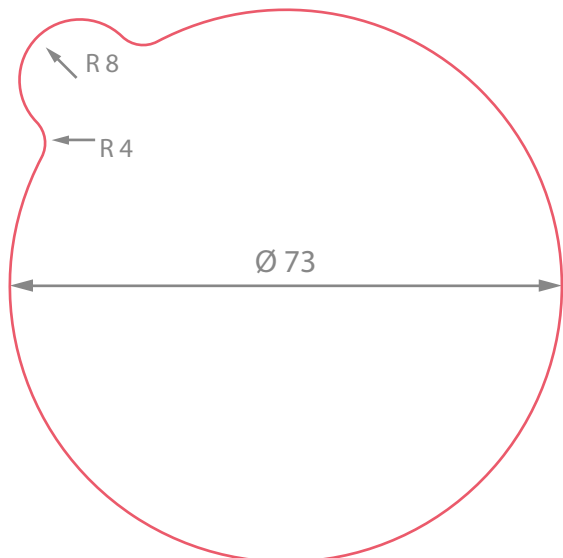
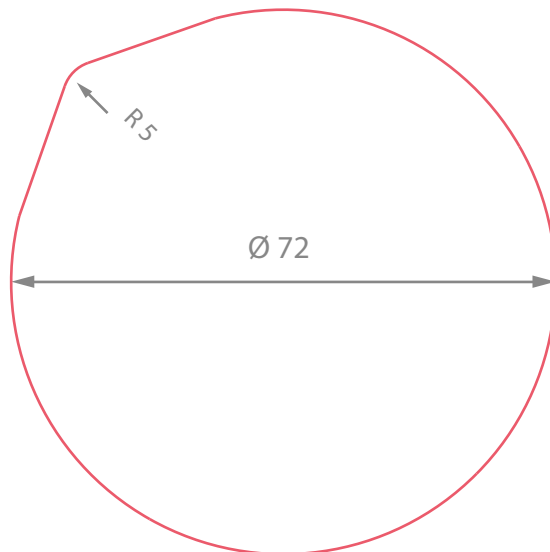
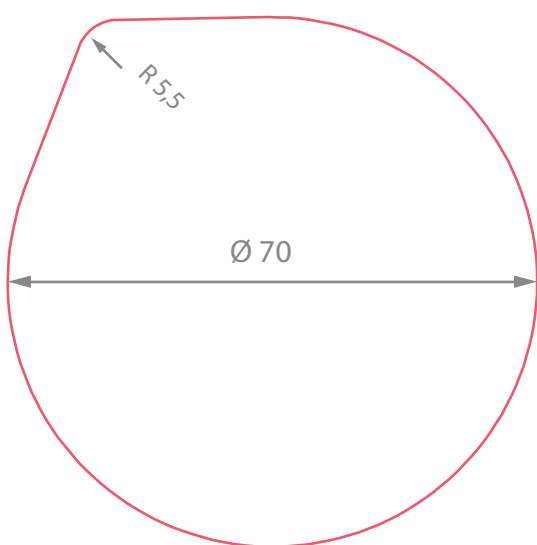

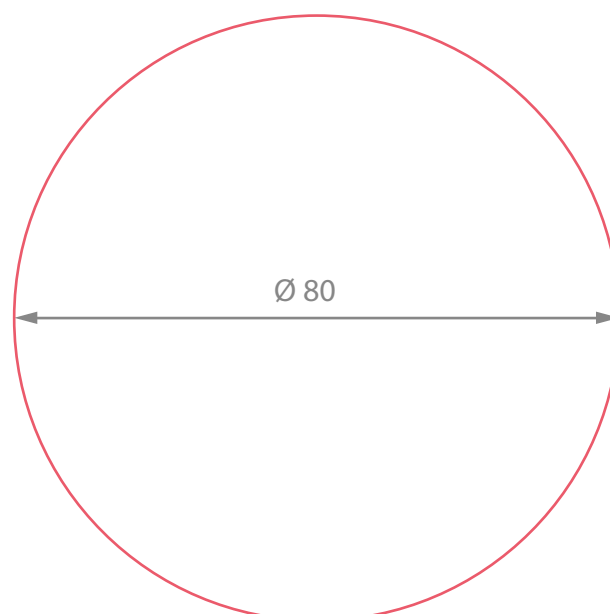
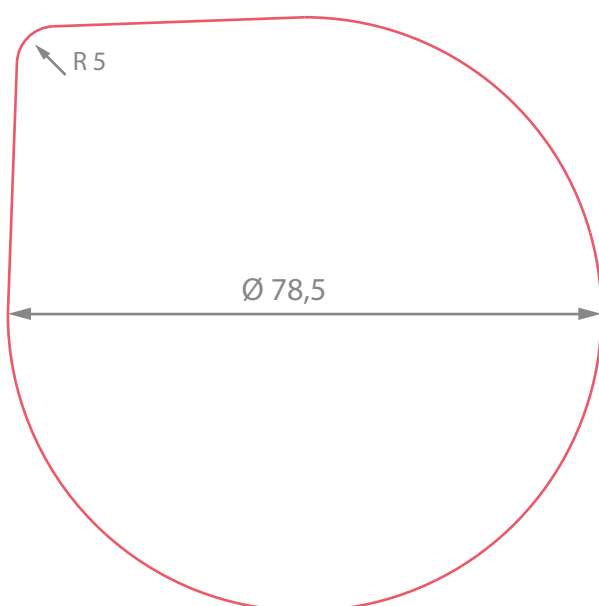
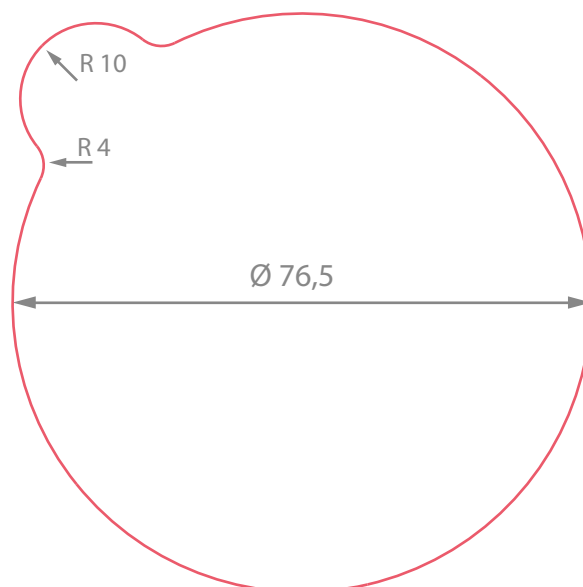
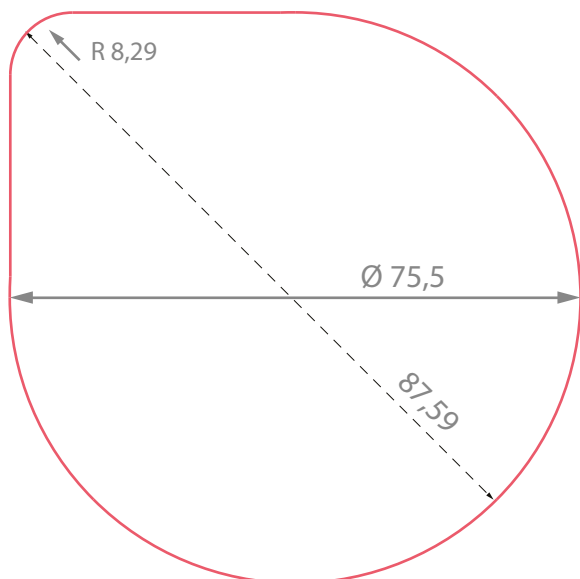

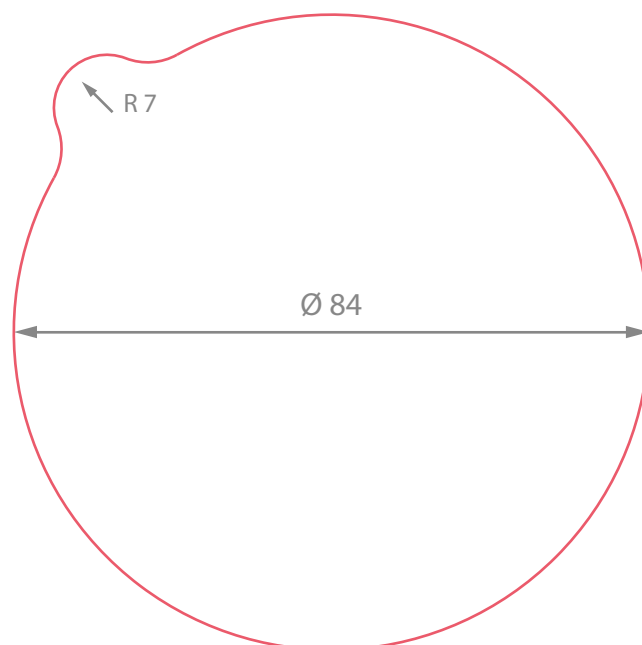
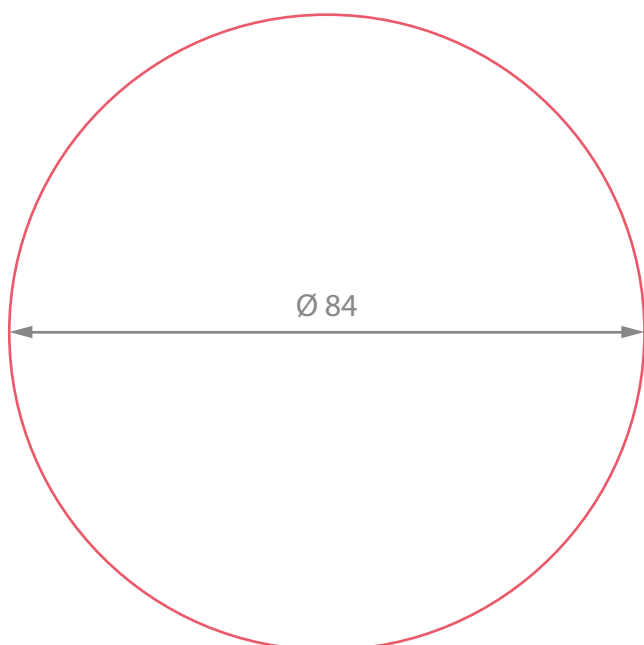
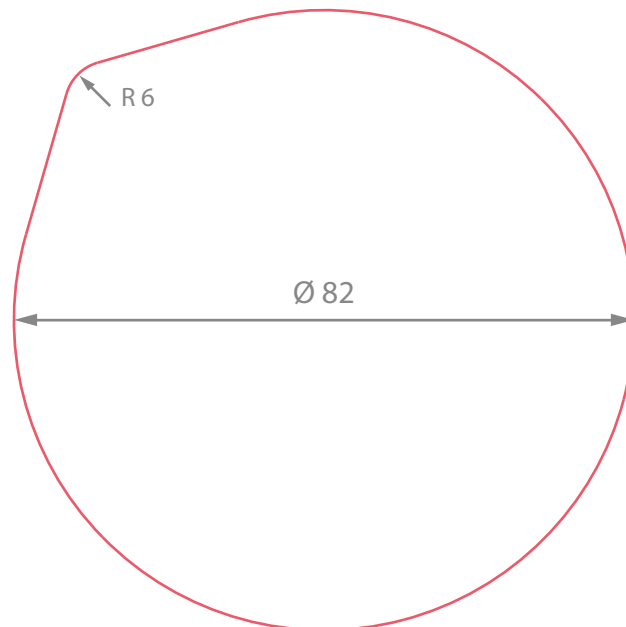
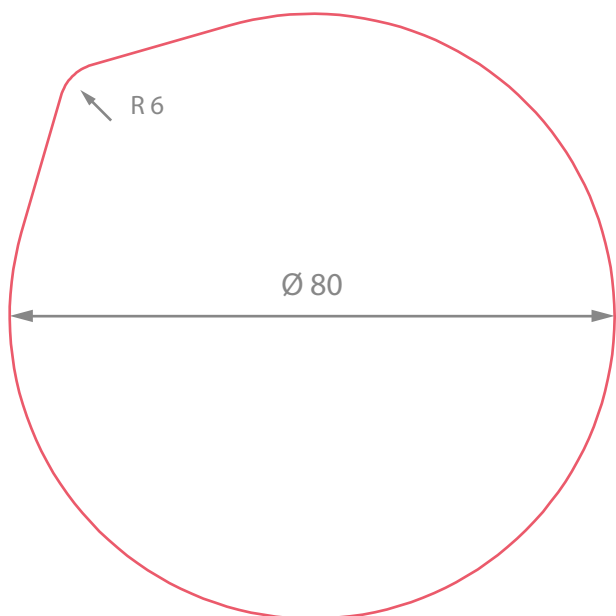



ALU·LIDS

Nowoczesna technologia = niewielki koszt  
Prosimy o przesłanie rysunku technicznego lub słoiczka, dobierzemy dla Państwa odpowiedni kształt i rozmiar lub wykonamy zupełnie nowy wzór

**10**  
**mm**

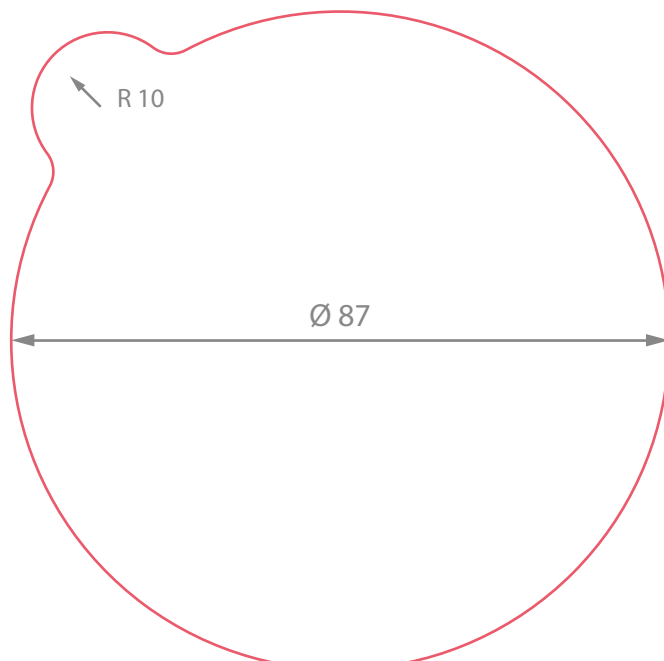
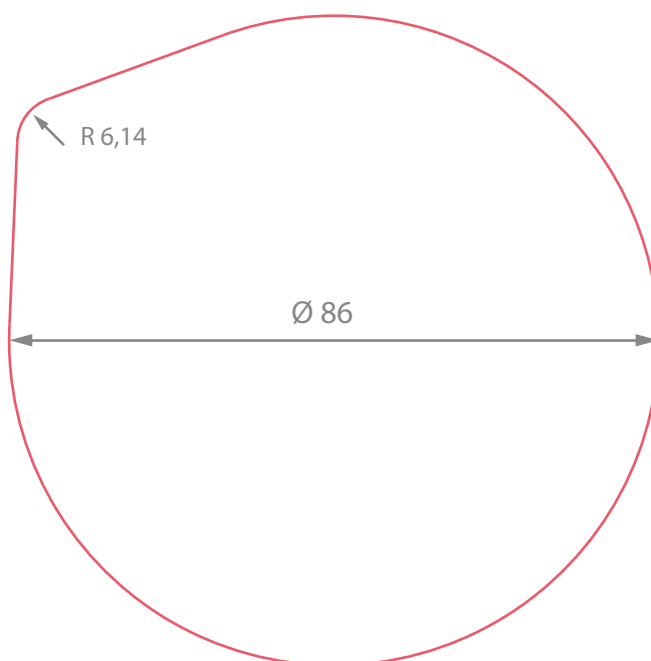
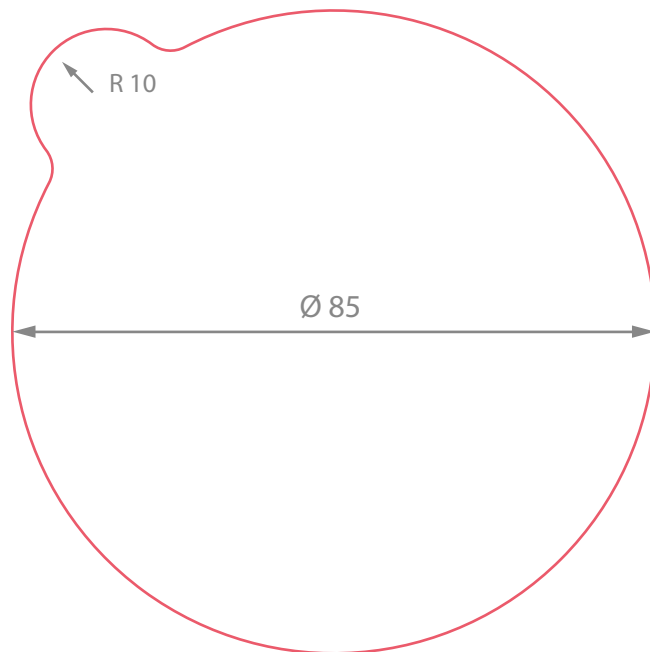
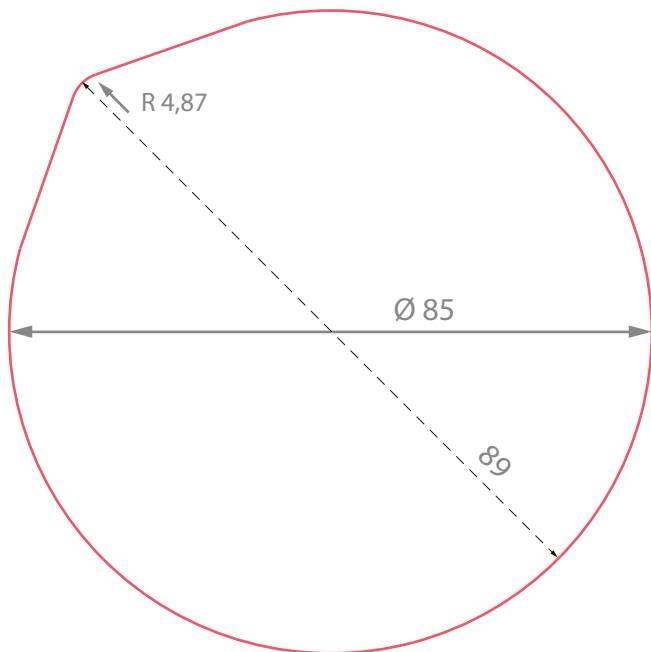



ALU·LIDS

Nowoczesna technologia = niewielki koszt  
Prosimy o przesłanie rysunku technicznego lub słoiczka, dobierzemy dla Państwa odpowiedni kształt i rozmiar lub wykonamy zupełnie nowy wzór

**10**  
**mm**

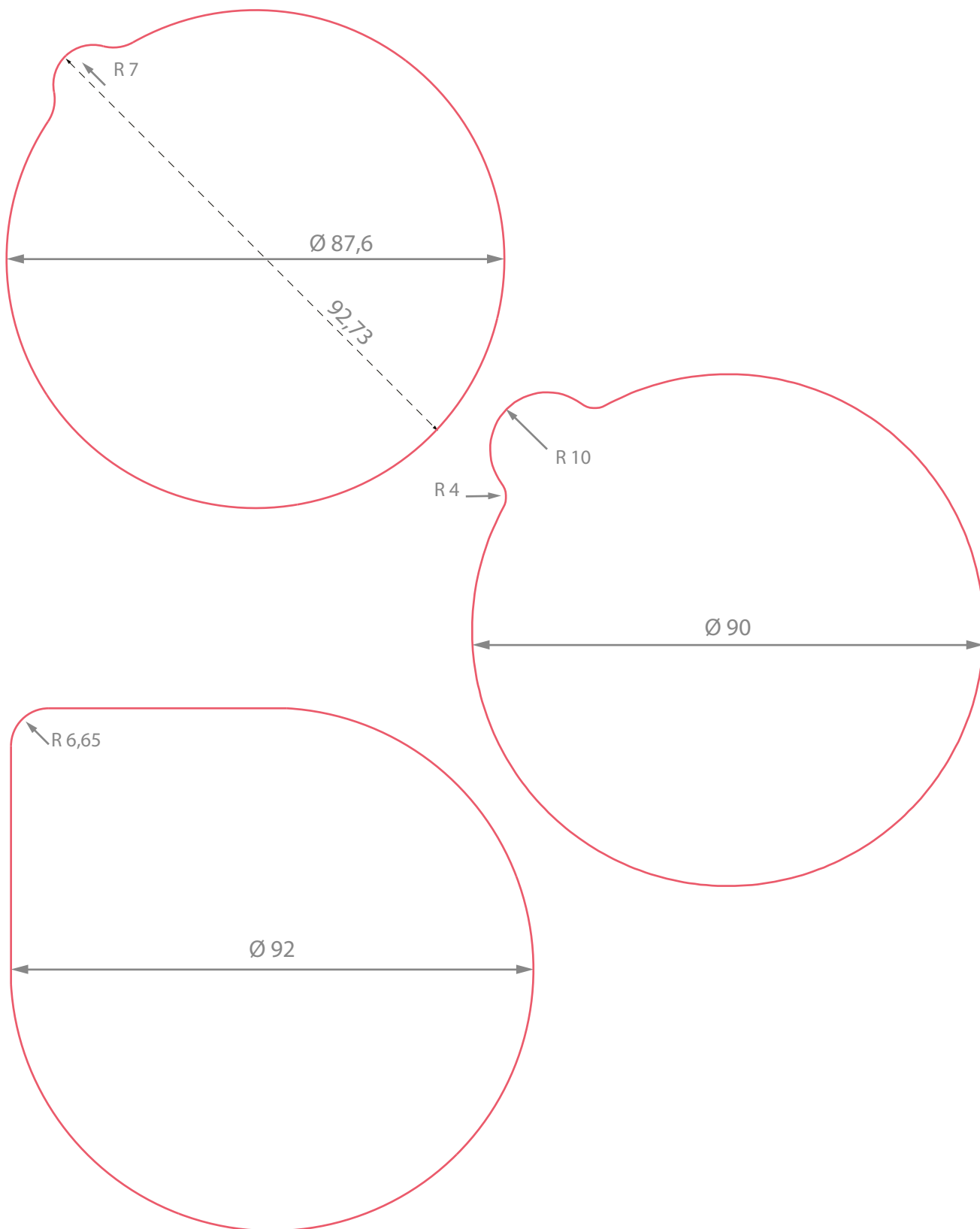





ALU·LIDS

Nowoczesna technologia = niewielki koszt  
Prosimy o przesłanie rysunku technicznego lub słoiczka, dobierzemy dla Państwa odpowiedni kształt i rozmiar lub wykonamy zupełnie nowy wzór

**10**  
**mm**

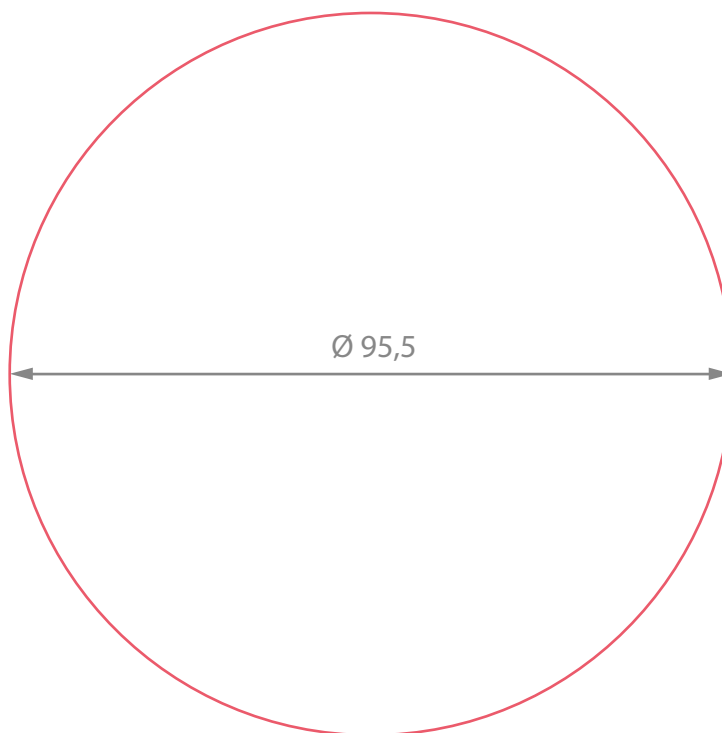
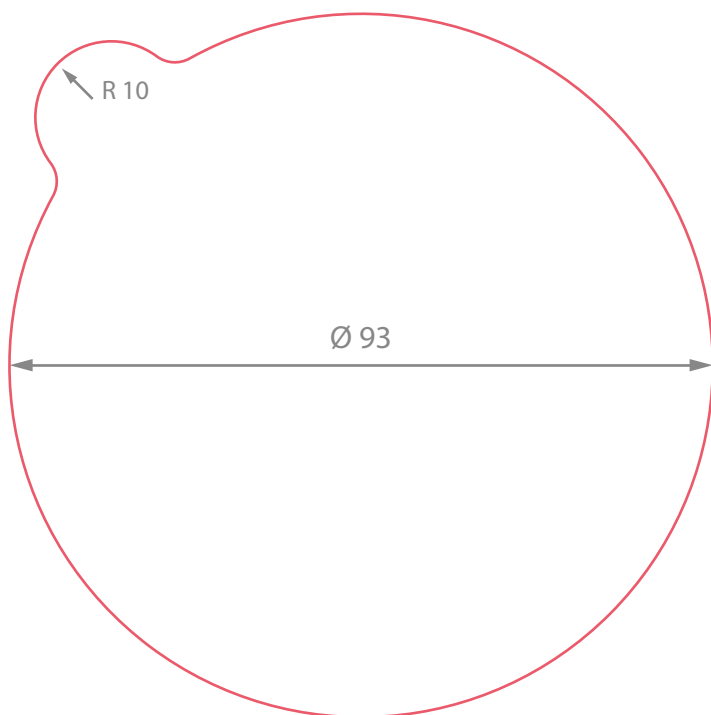



ALU·LIDS

Nowoczesna technologia = niewielki koszt  
Prosimy o przesłanie rysunku technicznego lub słoiczka, dobierzemy  
dla Państwa odpowiedni kształt i rozmiar lub wykonamy zupełnie nowy wzór

**10**  
**mm**

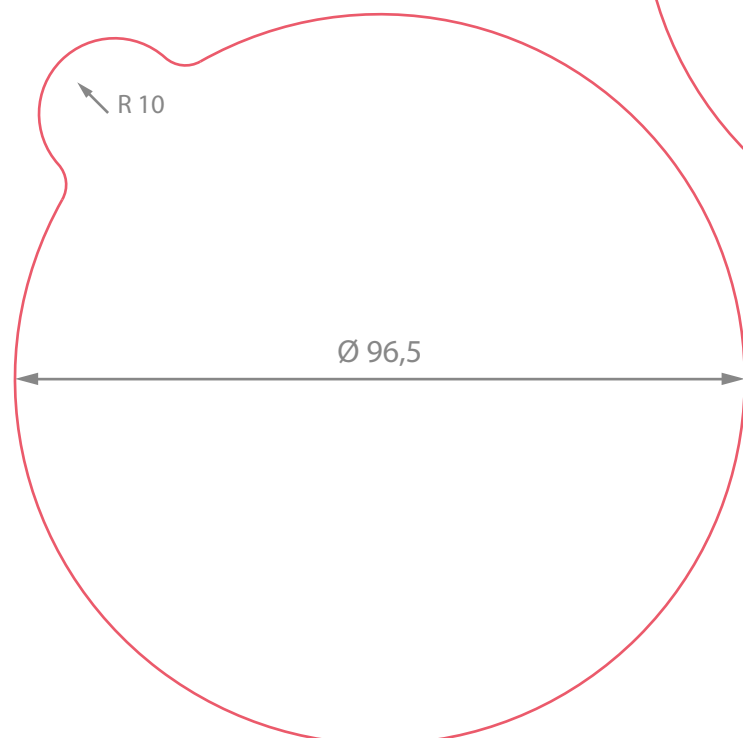
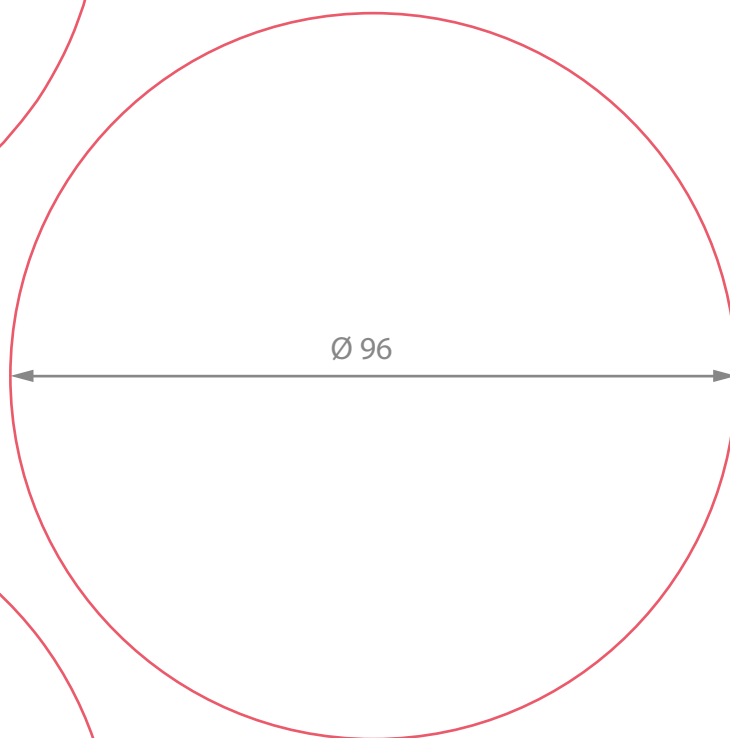
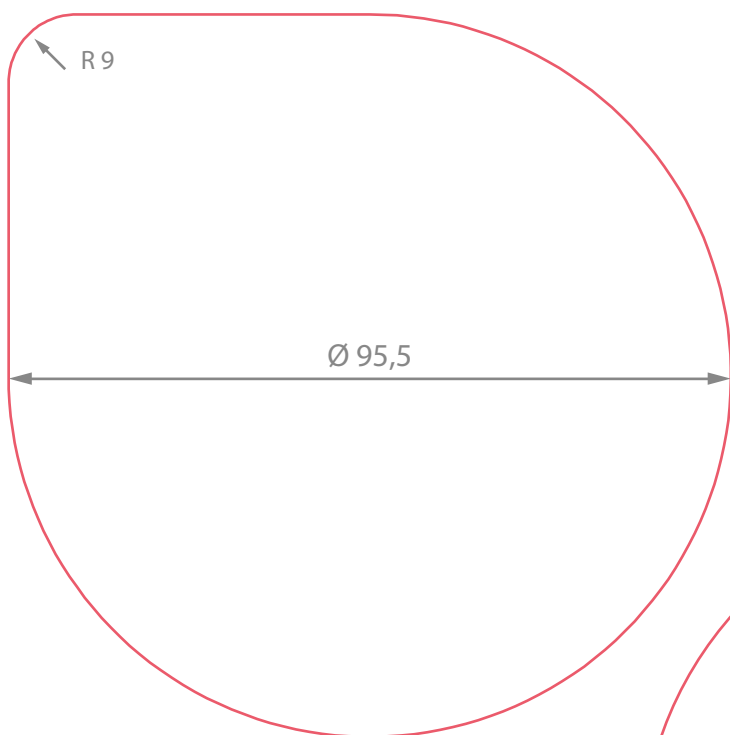



ALU·LIDS

Nowoczesna technologia = niewielki koszt  
Prosimy o przesłanie rysunku technicznego lub słoiczka, dobierzemy dla Państwa odpowiedni kształt i rozmiar lub wykonamy zupełnie nowy wzór

**10**  
**mm**

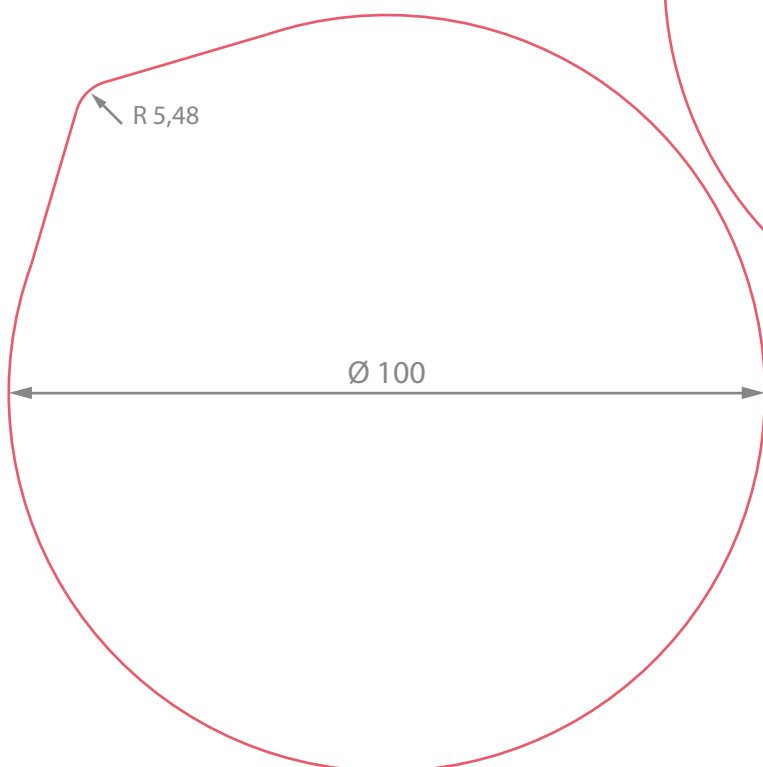
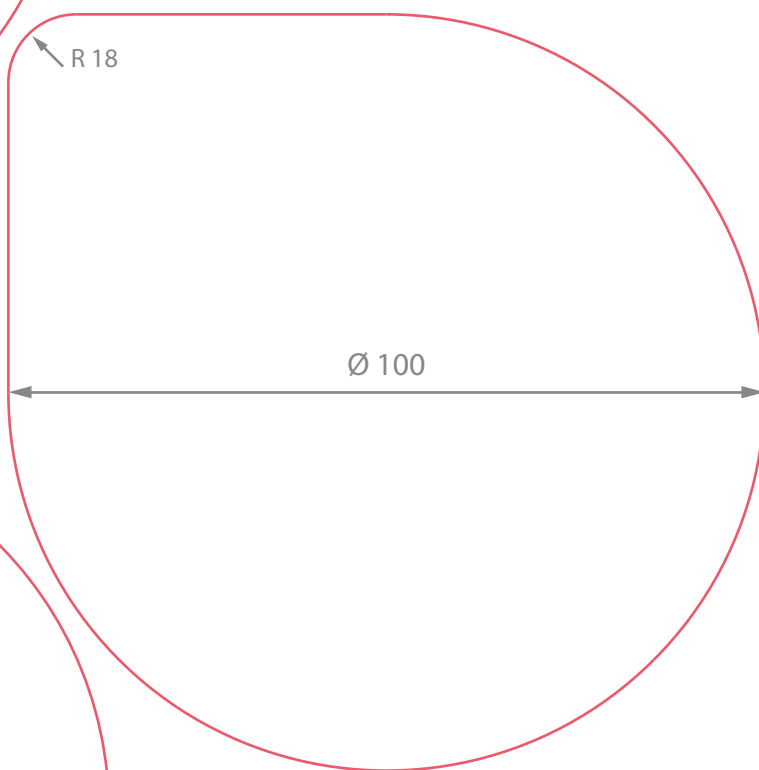
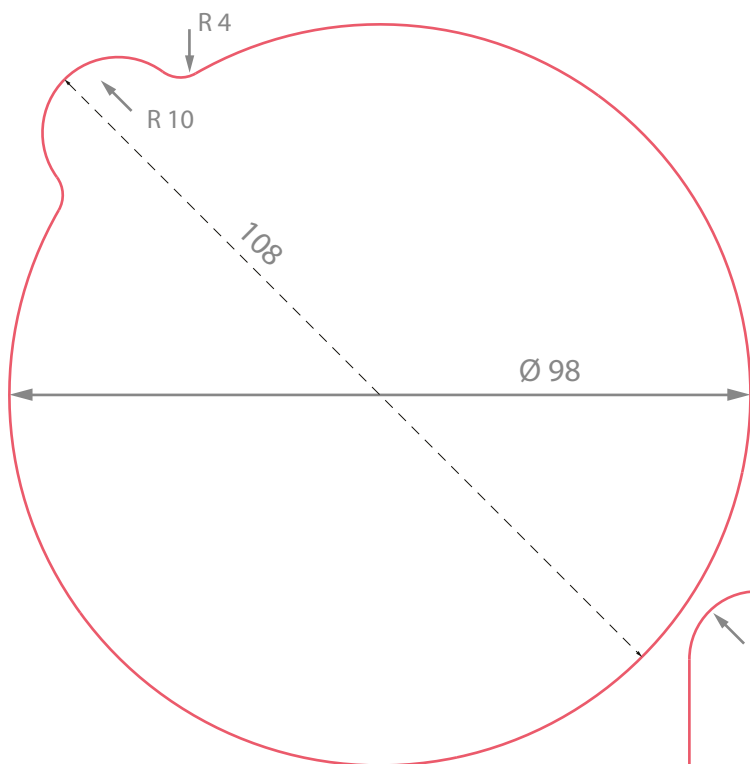

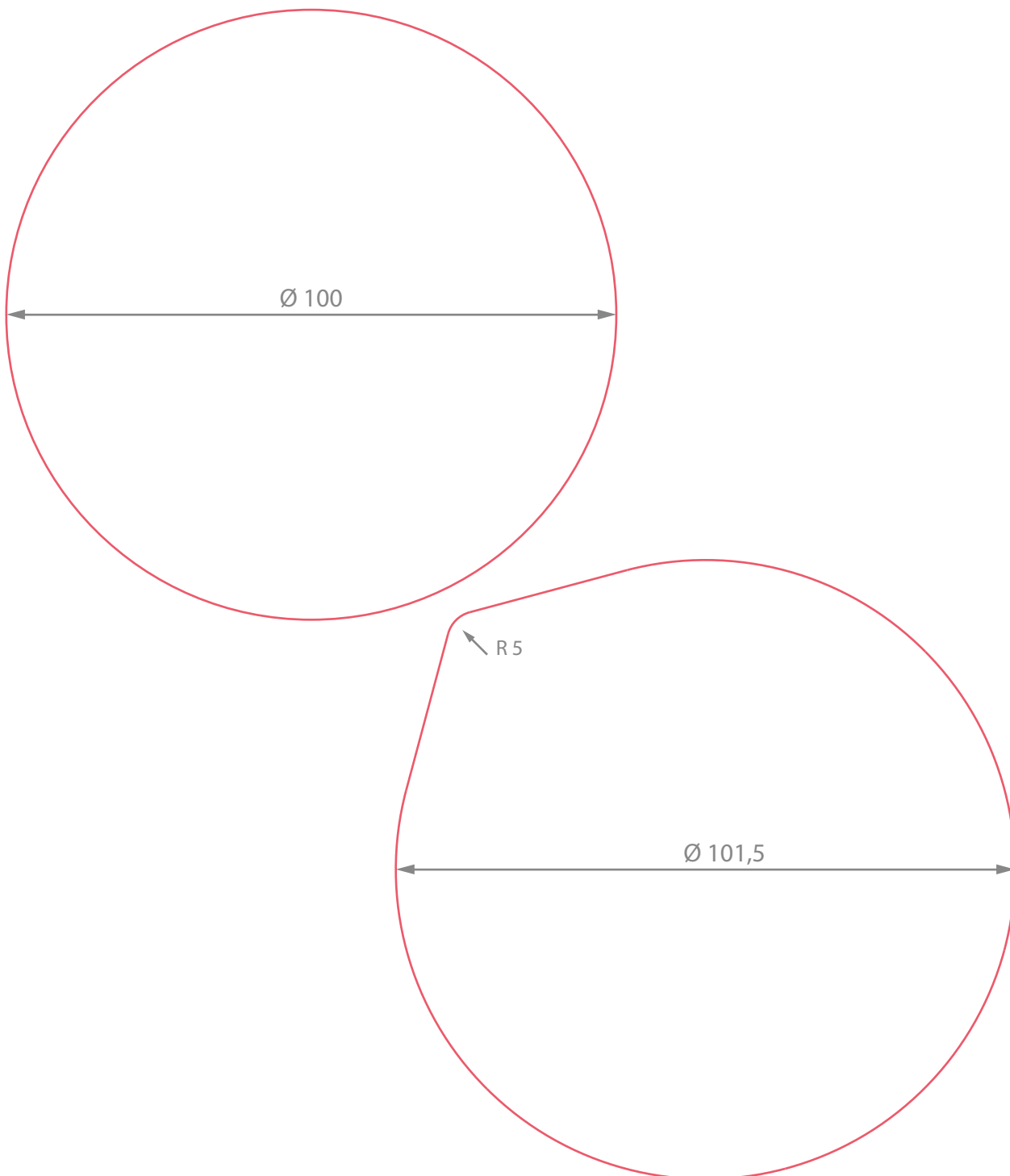



ALU·LIDS

Nowoczesna technologia = niewielki koszt  
Prosimy o przesłanie rysunku technicznego lub słoiczka, dobierzemy dla Państwa odpowiedni kształt i rozmiar lub wykonamy zupełnie nowy wzór

**10**  
**mm**

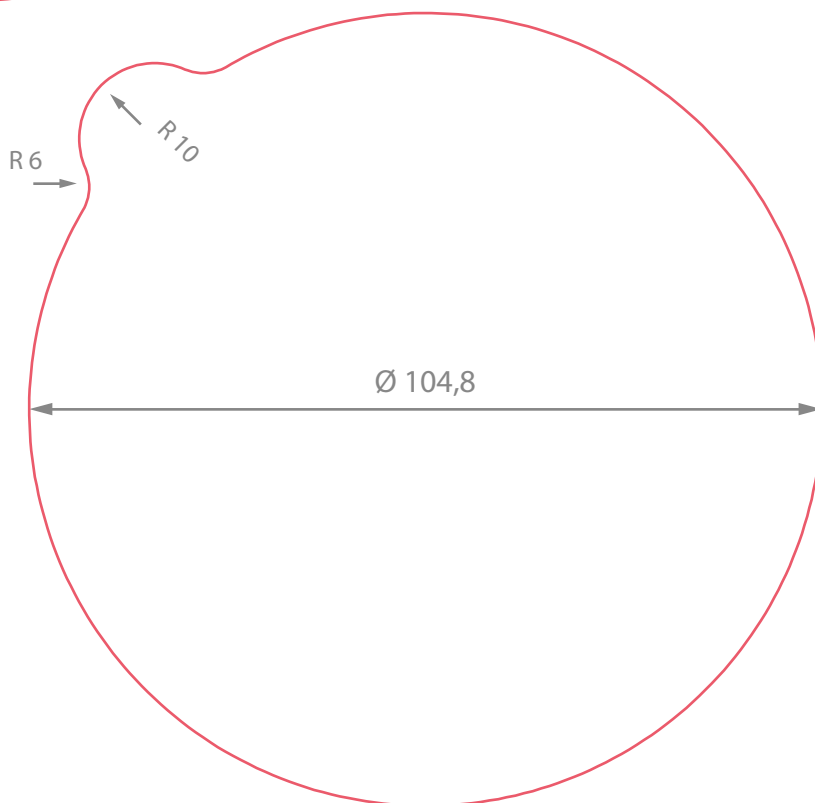
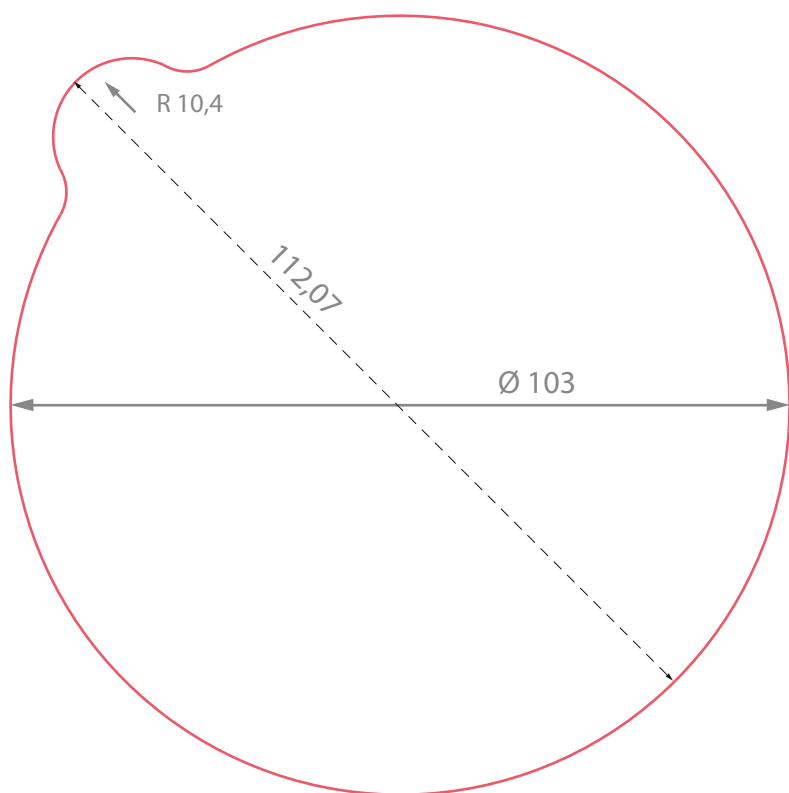



ALU·LIDS

Nowoczesna technologia = niewielki koszt  
Prosimy o przesłanie rysunku technicznego lub słoiczka, dobierzemy  
dla Państwa odpowiedni kształt i rozmiar lub wykonamy zupełnie nowy wzór

**10**  
**mm**

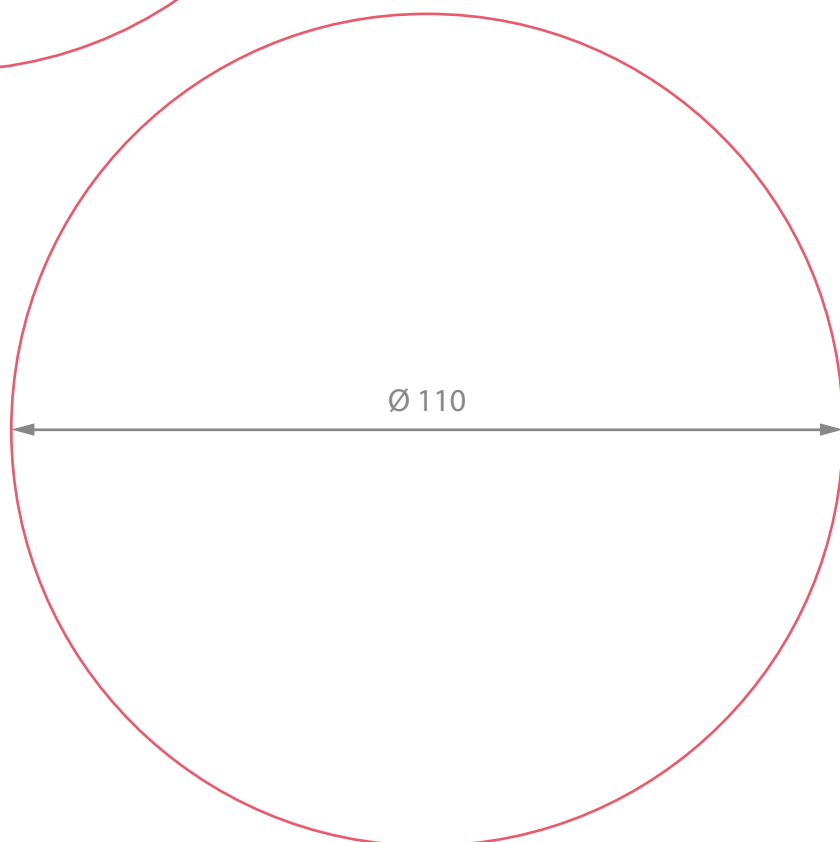
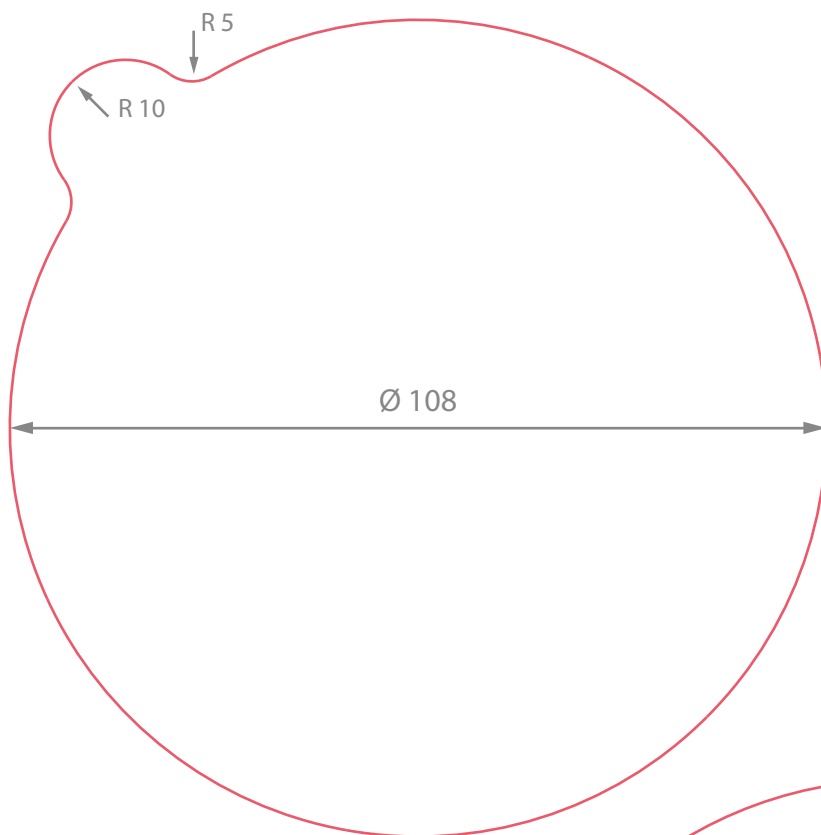



ALU·LIDS

Nowoczesna technologia = niewielki koszt  
Prosimy o przesłanie rysunku technicznego lub stoiczka, dobierzemy dla Państwa odpowiedni kształt i rozmiar lub wykonamy zupełnie nowy wzór

**10**  
**mm**

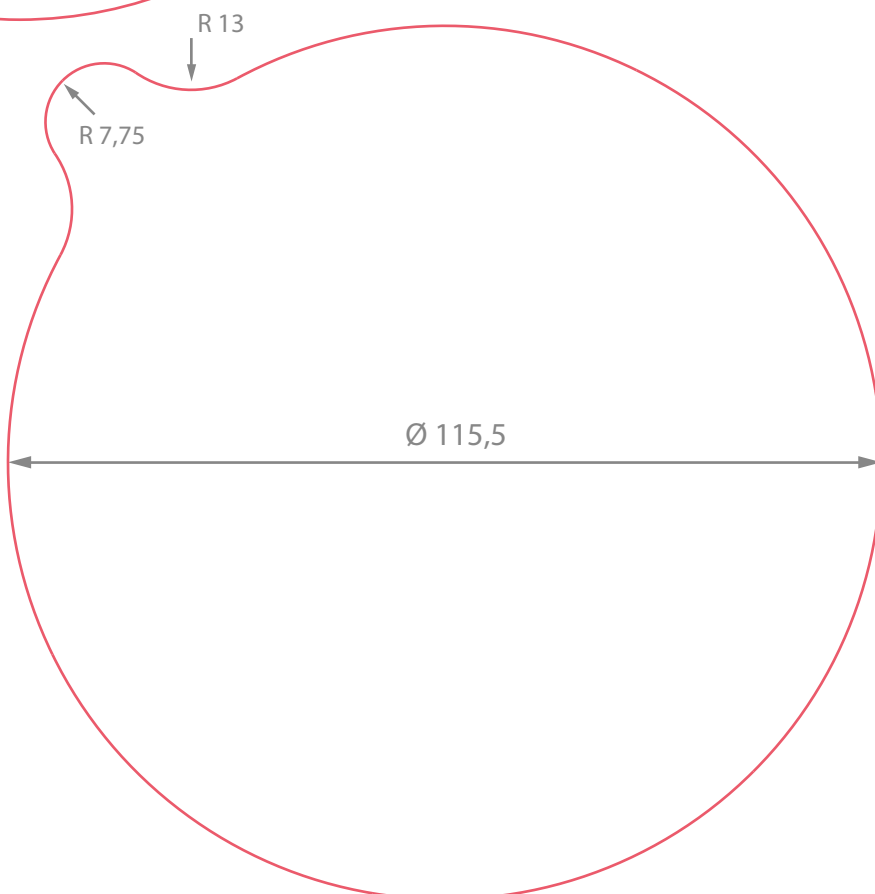
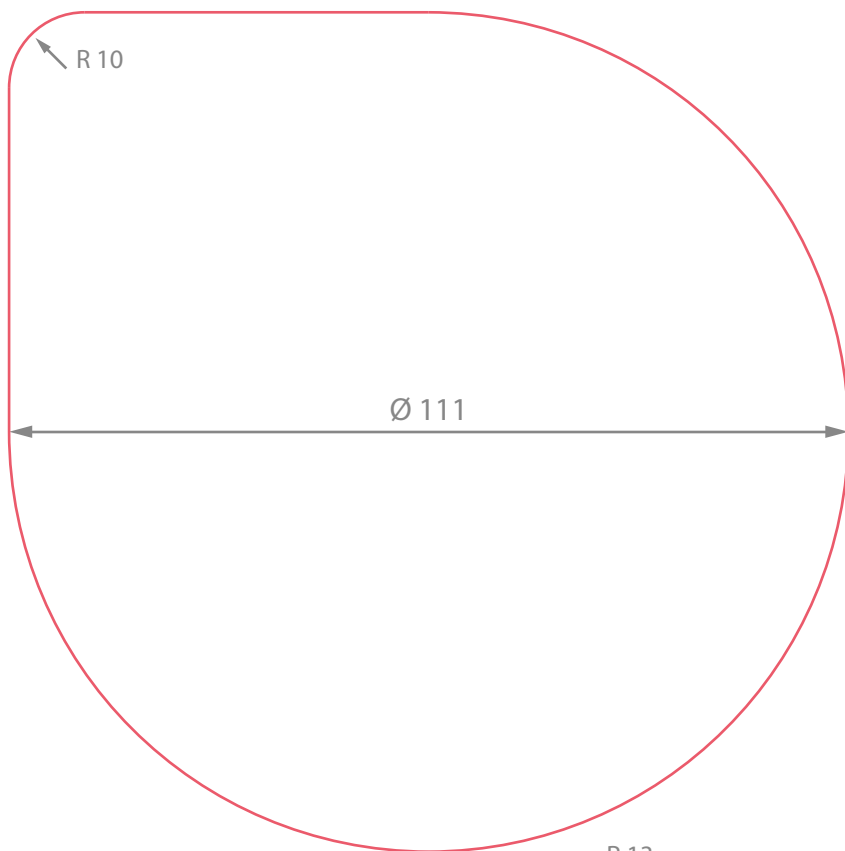



ALU·LIDS

Nowoczesna technologia = niewielki koszt  
Prosimy o przesłanie rysunku technicznego lub słoiczka, dobierzemy dla Państwa odpowiedni kształt i rozmiar lub wykonamy zupełnie nowy wzór

**10**  
**mm**

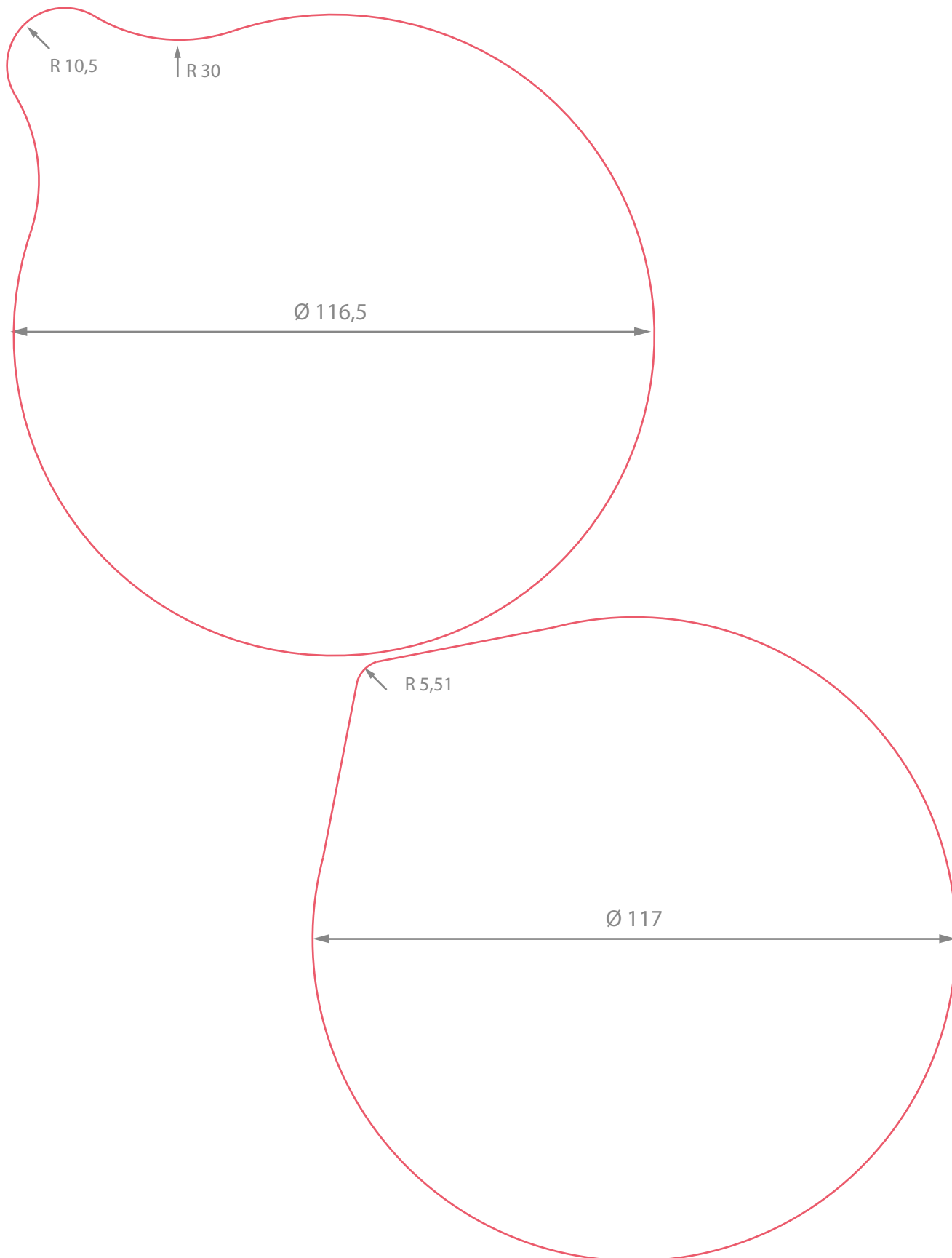



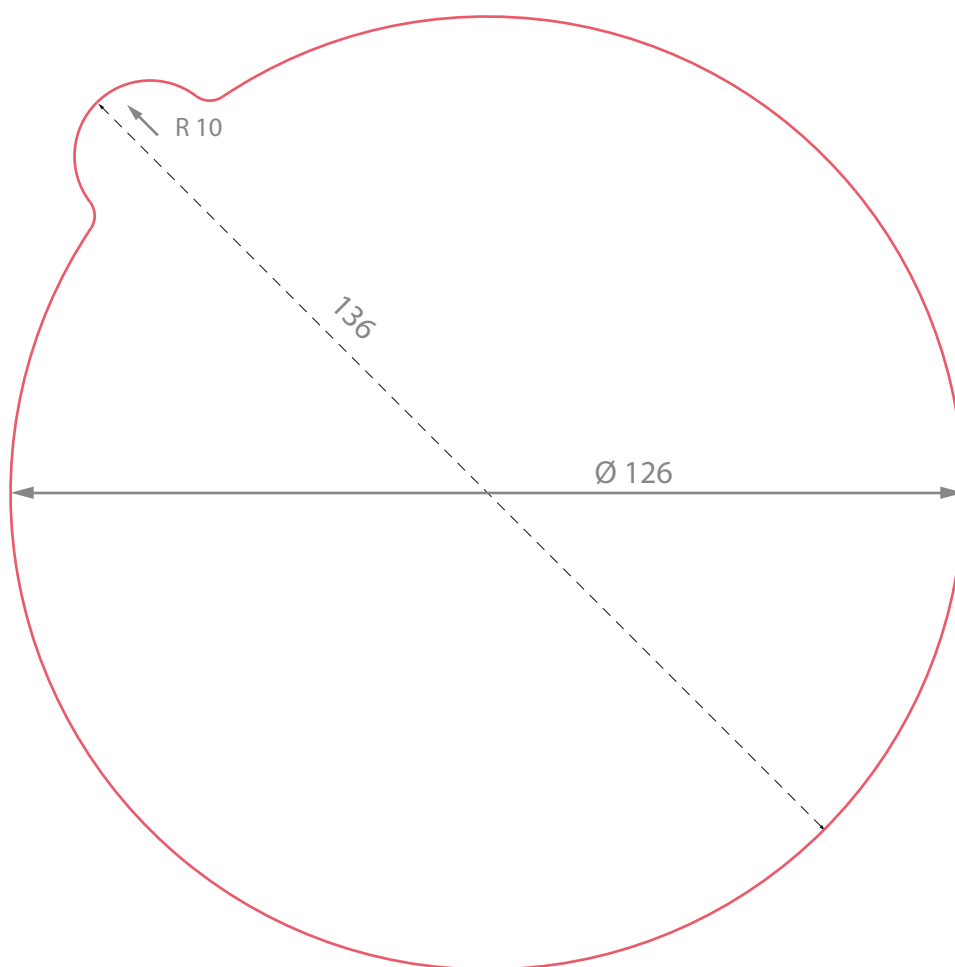

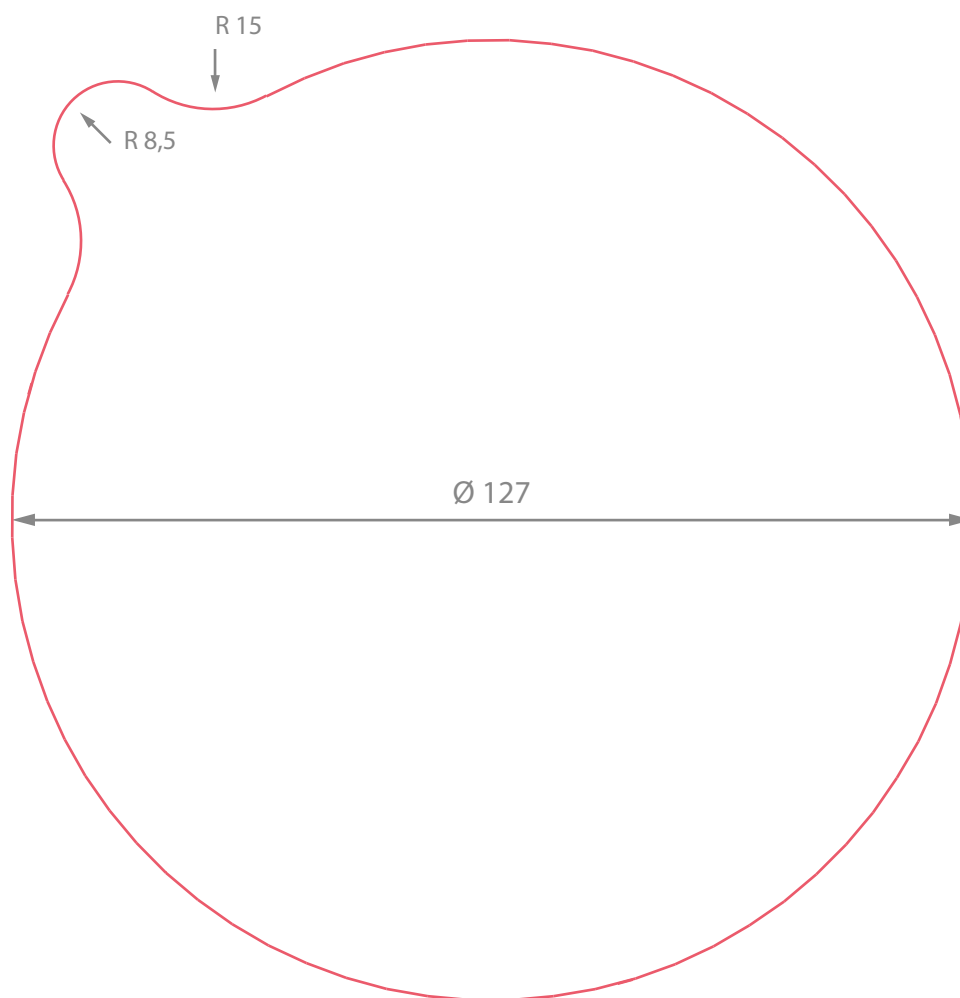

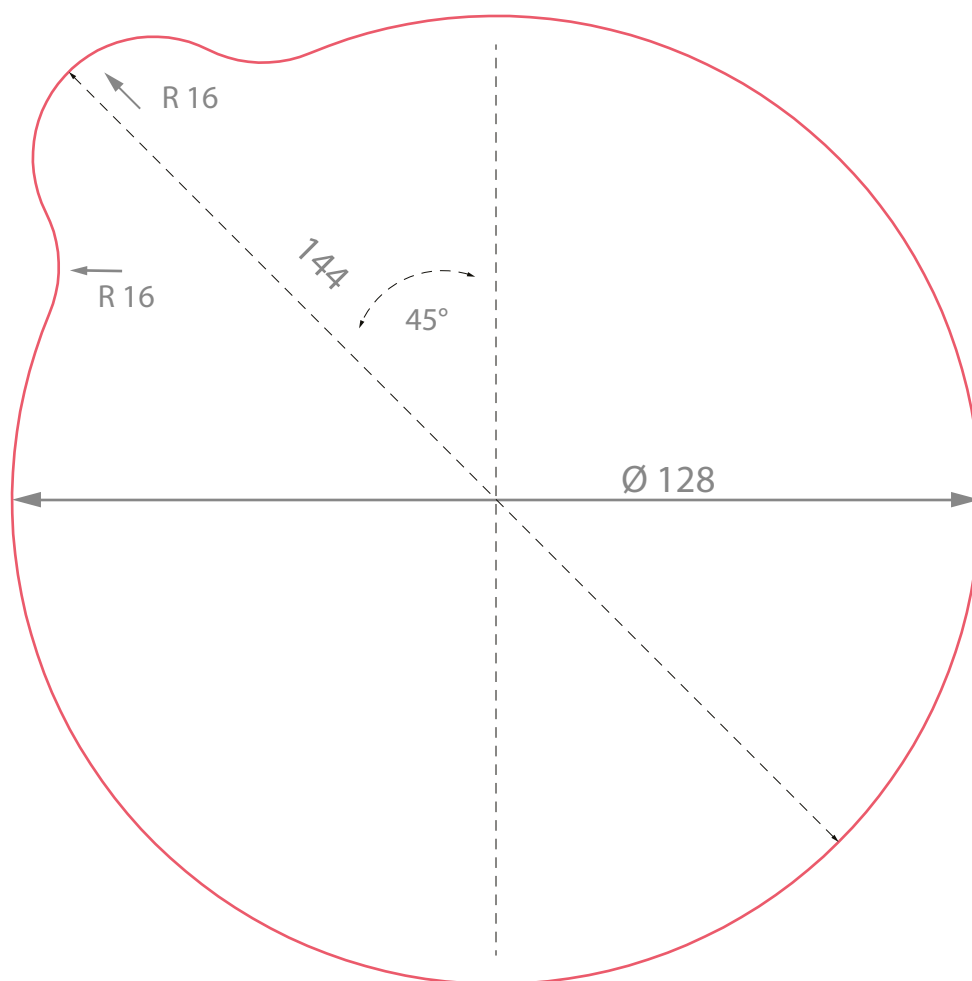

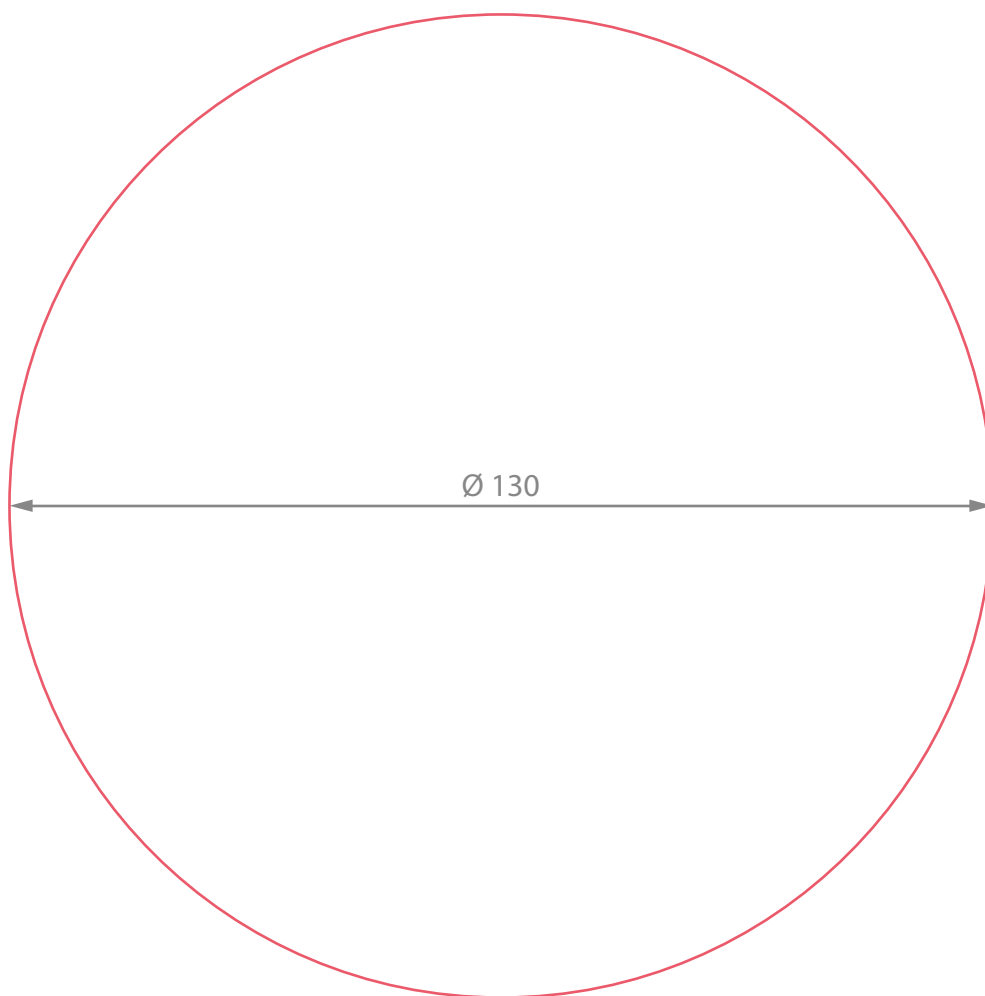

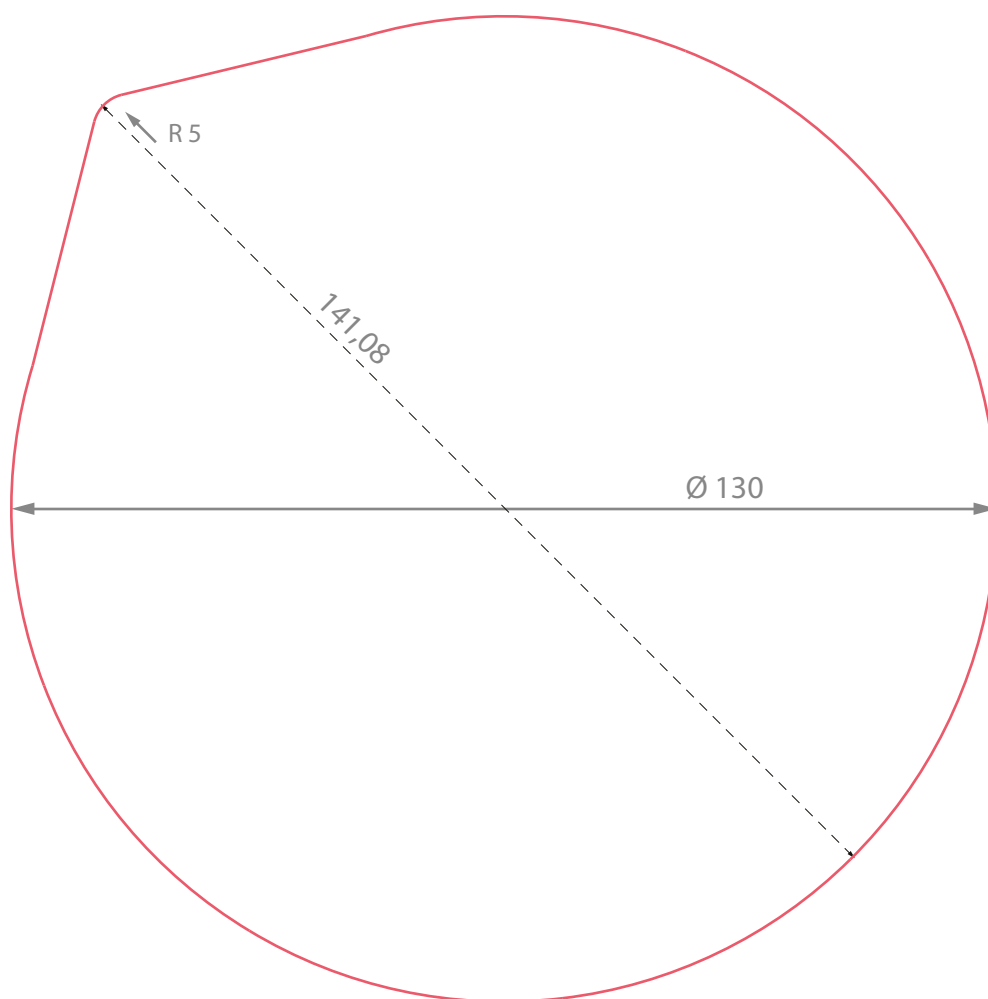

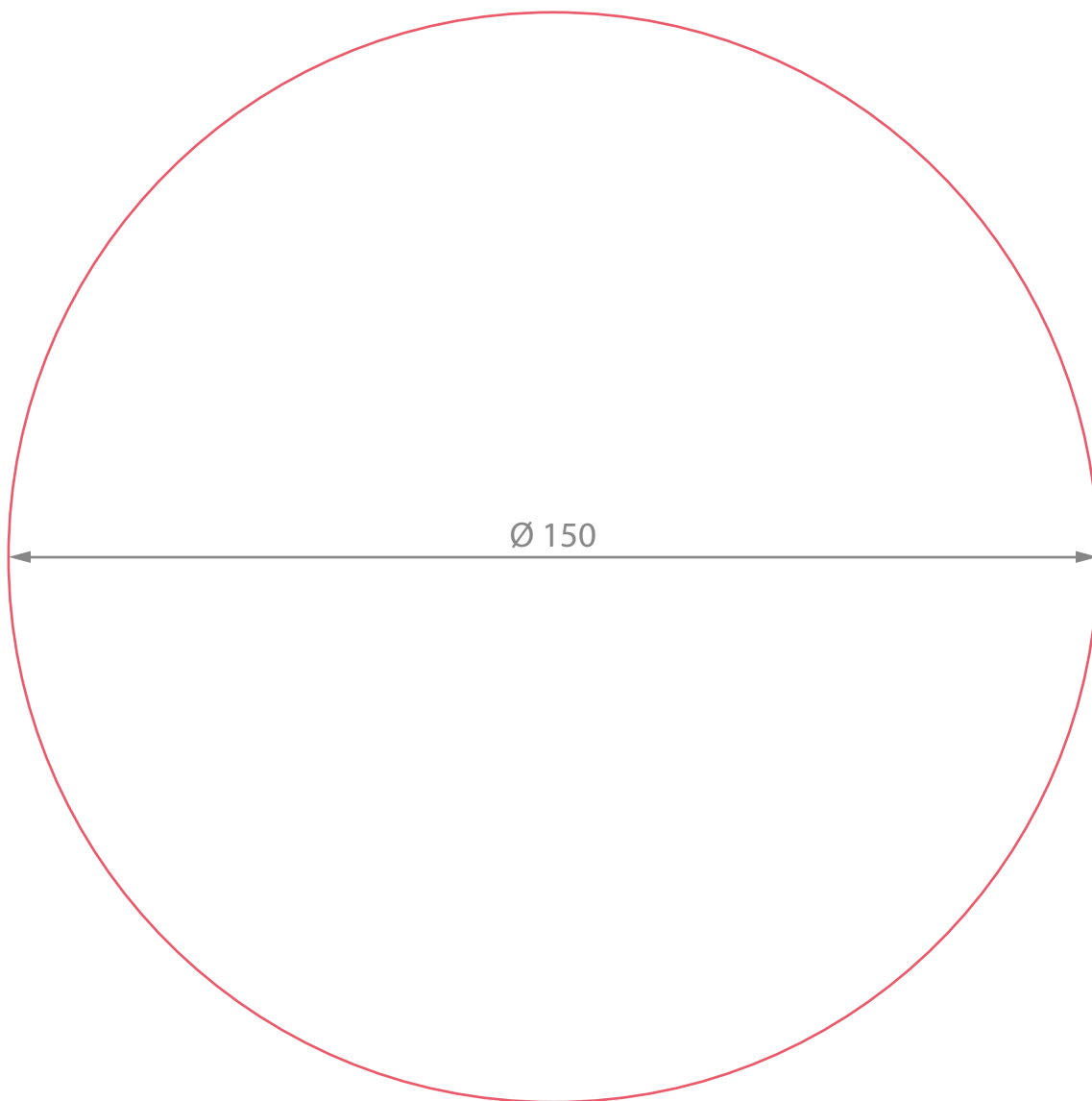

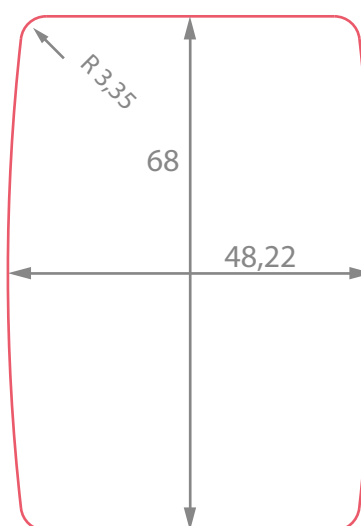
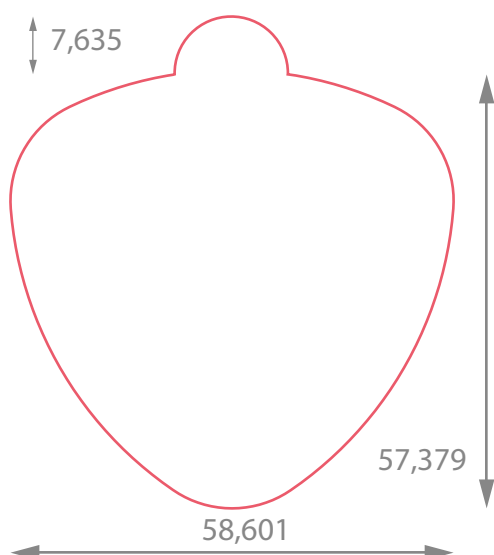
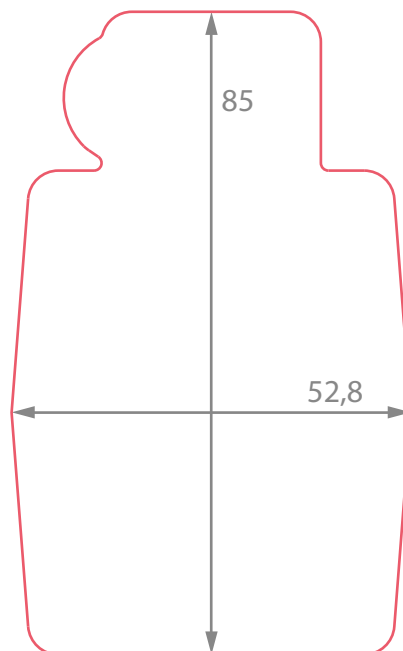
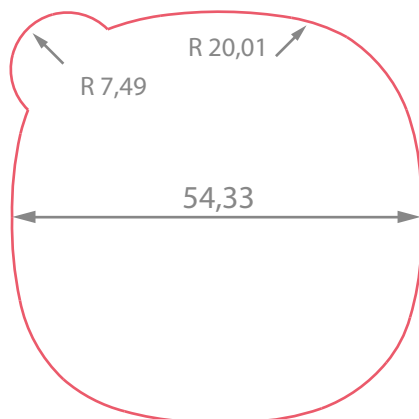
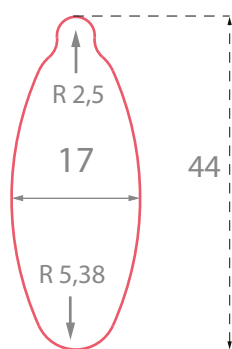



ALU·LIDS

Nowoczesna technologia = niewielki koszt  
Prosimy o przesłanie rysunku technicznego lub stoiczka, dobierzemy dla Państwa odpowiedni kształt i rozmiar lub wykonamy zupełnie nowy wzór

**10**  
**mm**

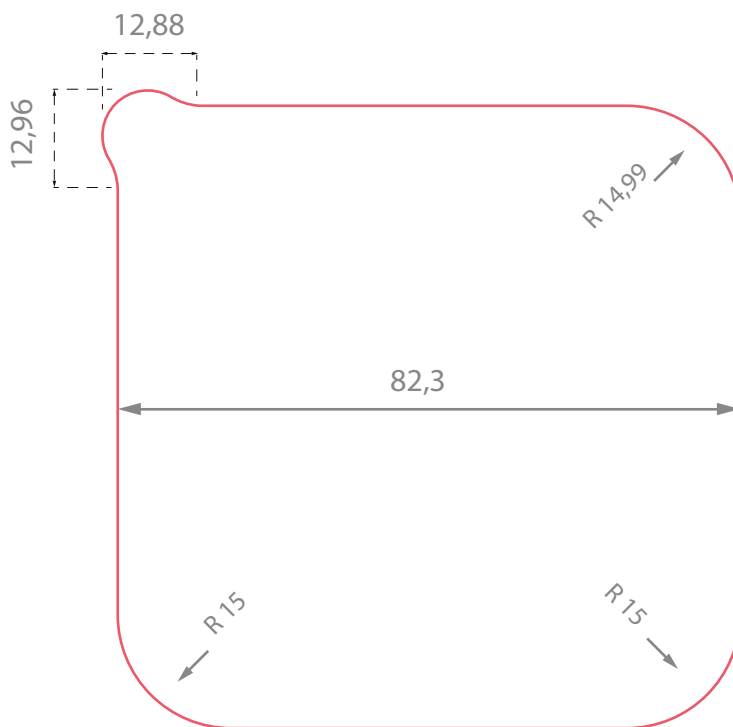
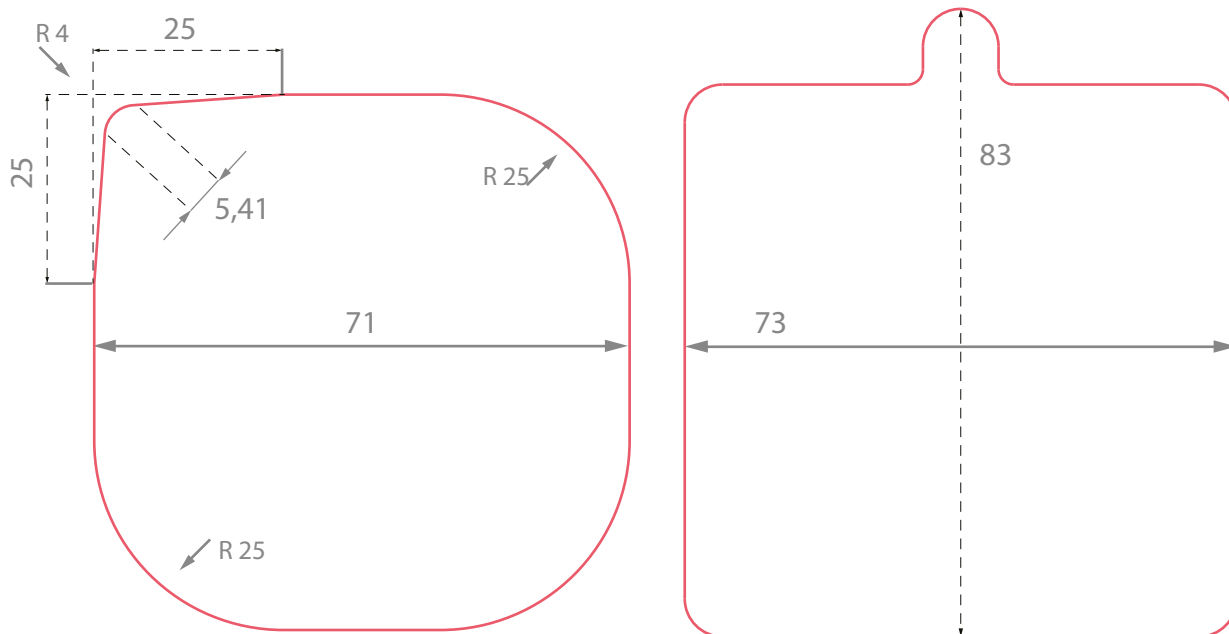



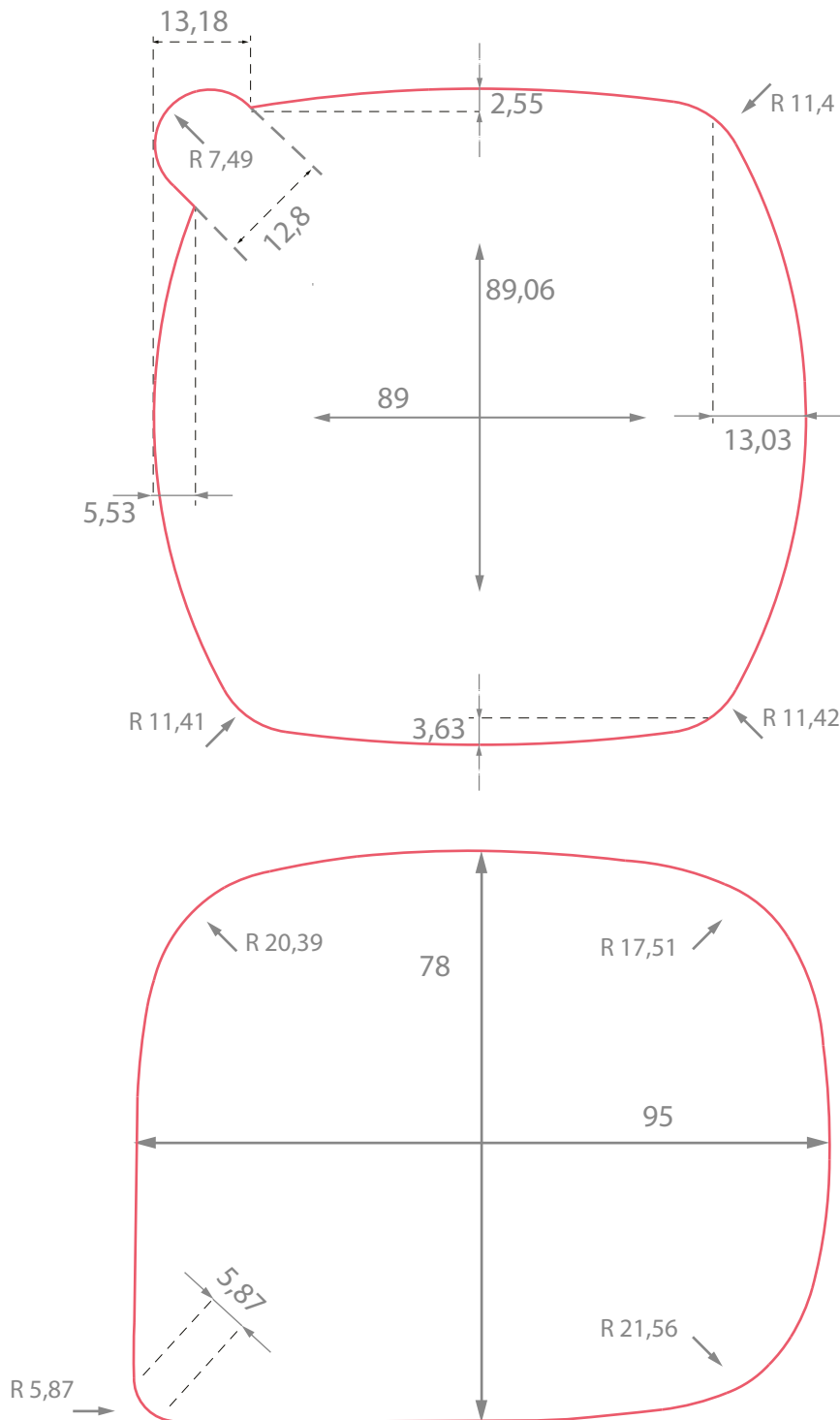

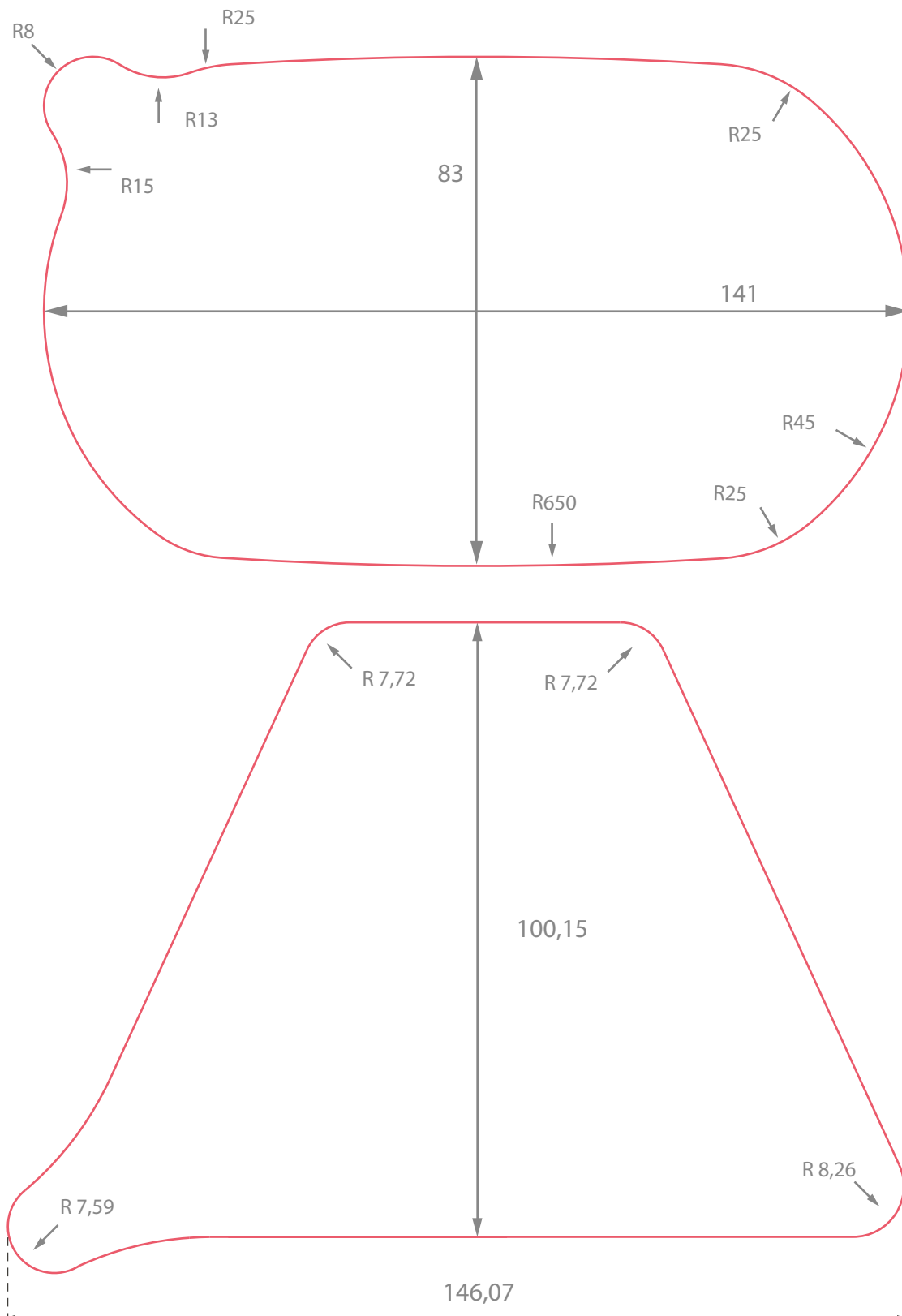



ALU·LIDS

Nowoczesna technologia = niewielki koszt  
Prosimy o przesłanie rysunku technicznego lub słoiczka, dobierzemy dla Państwa odpowiedni kształt i rozmiar lub wykonamy zupełnie nowy wzór

**10**  
**mm**

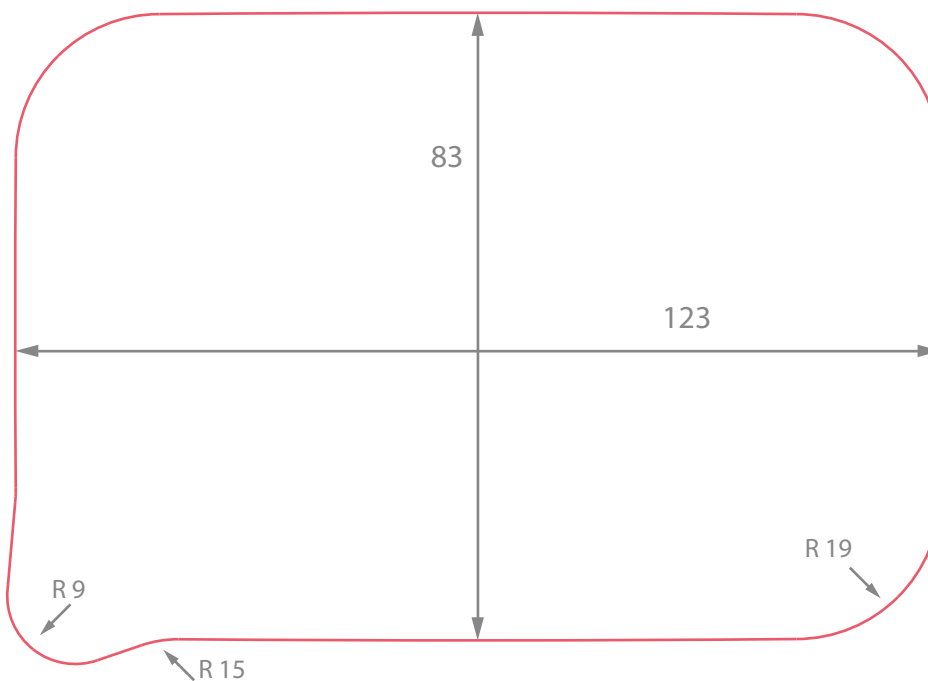
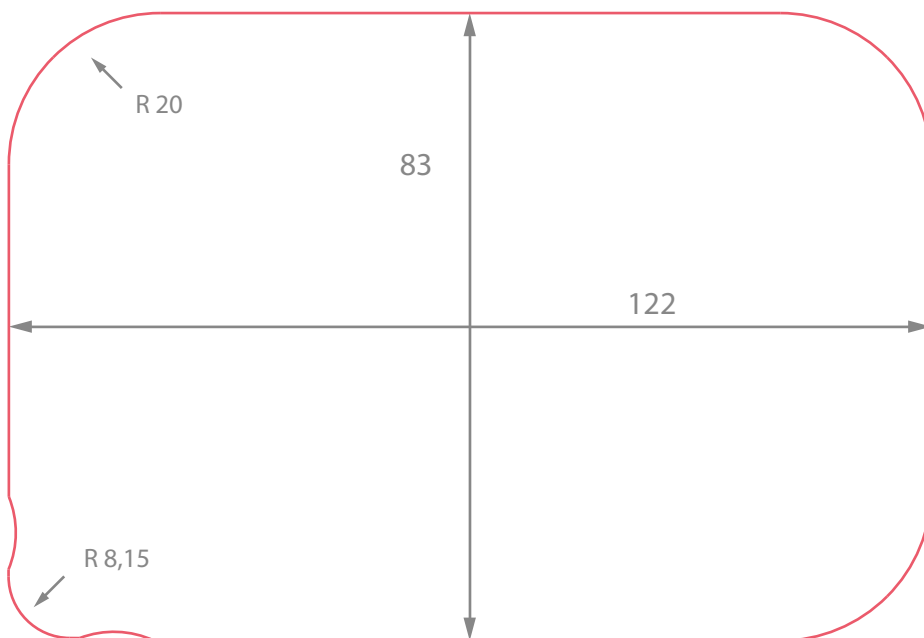

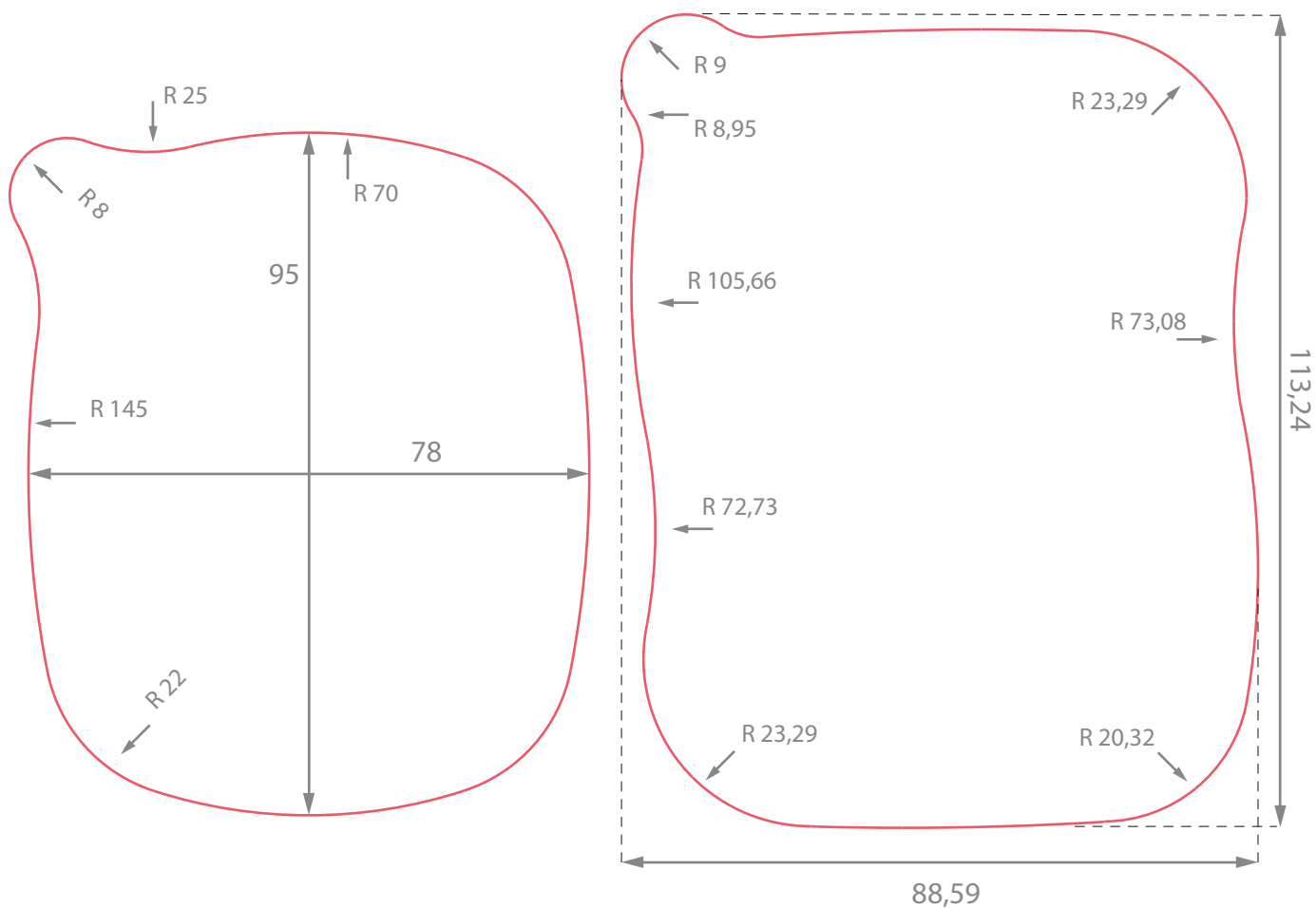
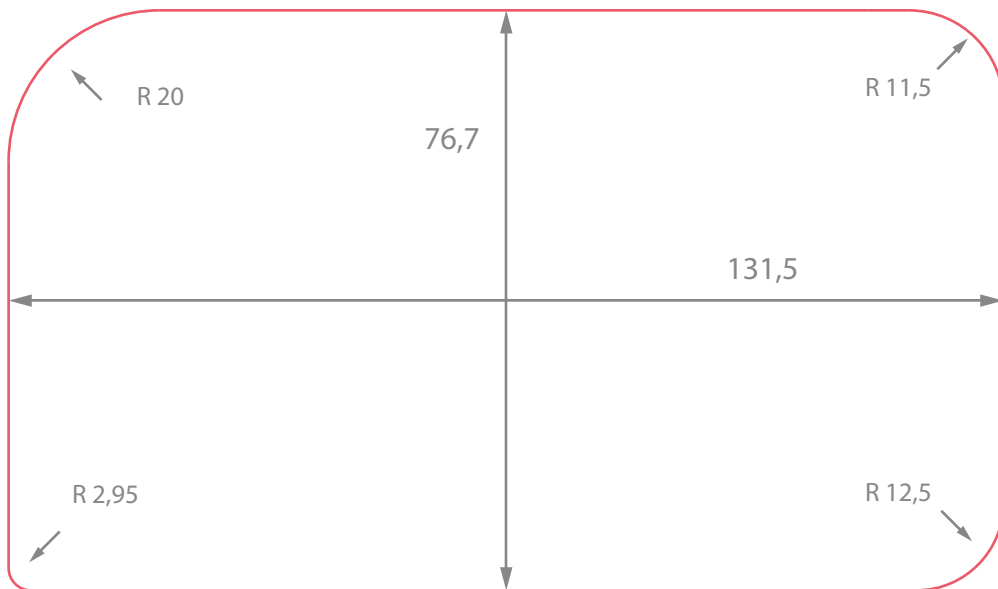

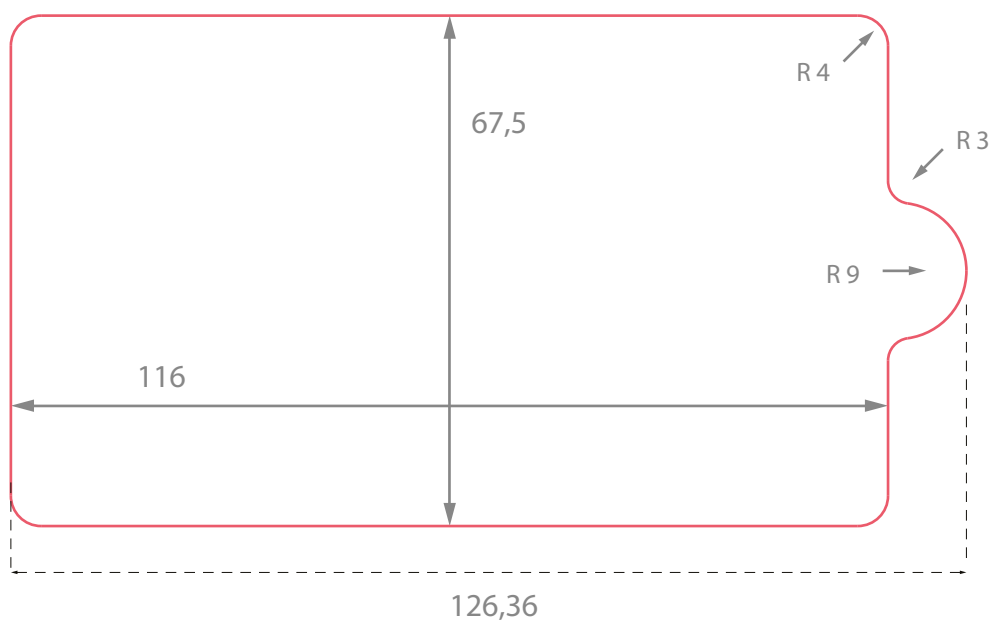
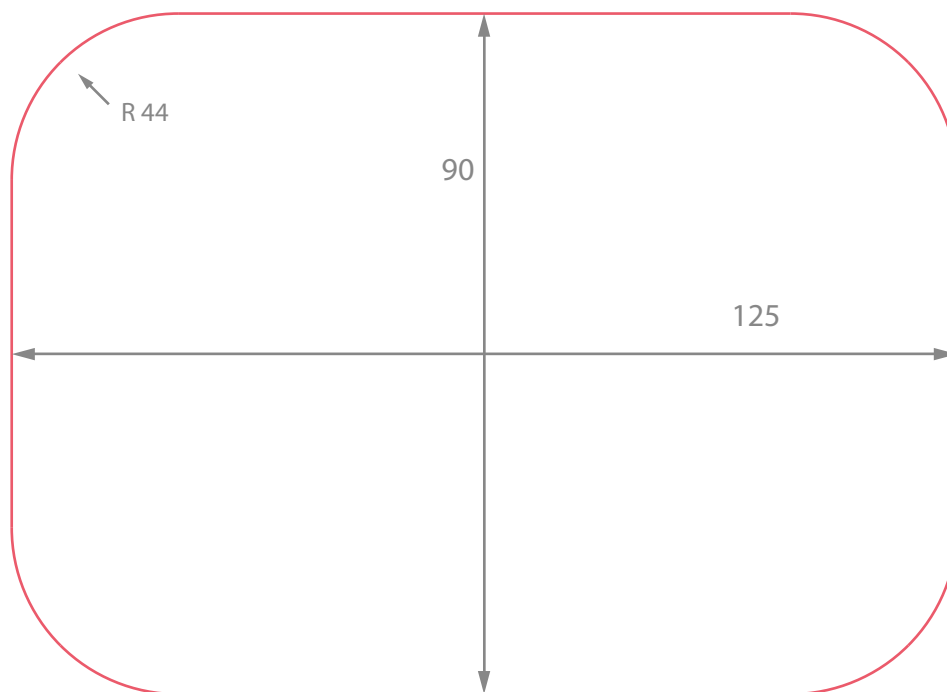



ALU·LIDS

Nowoczesna technologia = niewielki koszt  
Prosimy o przesłanie rysunku technicznego lub słoiczka, dobierzemy dla Państwa odpowiedni kształt i rozmiar lub wykonamy zupełnie nowy wzór

**10**  
**mm**

